

AMERICAN  
SCIENTIFIC  
PUBLISHERS

Copyright © XXXX American Scientific Publishers  
All rights reserved  
Printed in the United States of America

Advanced Science Letters  
Vol. XXXXXXXXX

# Use of ICT's to Generate Real-Time Alerts Based on the Automatic Analysis by the Artificial Vision System That Monitors Eruptive Processes

Cruz Christyan<sup>1</sup>, Viteri Francisco<sup>1</sup>, Barrera Kevin<sup>1</sup>, Darío José Mendoza Chipantasi<sup>1</sup>

<sup>1</sup>Departamento de Ciencias de la Energía y Mecánica, Universidad de las Fuerzas Armadas ESPE, Sangolquí 171-5-231B, Ecuador

The great potential, reliability and the high number of applications made through artificial vision, are fundamental for the development of a monitoring system pyroclastic flows for active volcanoes axis through a platform called Raspberry Pi based on free software (Ubuntu), the great potential of it allows you to run several software for the application of computer vision techniques, make data processing and also control outputs from the same board. Thus the main points to note when using an embedded system are a stable data acquisition, fast processing and control outputs to operate alarm systems, but especially the cost is reduced and reliable system.

**Keywords:** Alarms, Pyroclastic flows, Raspberry Pi, Artificial Vision.

## 1. INTRODUCTION

The use ICTs to develop and deploy new applications that generate large-scale utility in risk areas, provides a great social contribution in the event of a natural disaster of volcanic character. Today technology has advanced at great scale, reducing costs and sizes in processors and placing them on the market for commercialize them, as in the case of platforms such as Raspberry Pi whose functionality embedded system is the main aspect that can be highlighted as allows data acquisition, processing and generating signals<sup>1,9</sup> through its ports, which combined with free programming language as the case of Python allows the realization of applications focused on monitoring eruptive processes through the use of artificial vision and generation of early warnings.

cmcruz1@espe.edu.ec

Alarm systems actived in case of eruption may be sound and light type, where the use of GPIO ports (Inputs and Outputs General Purpose), provide connections from the control board to the external environment, before processing performed<sup>1</sup>. Within audible alarms the best example and implemented are sirens due to its large earshot to alert the population, which together with system lights of high brightness can form a preventive system of high efficiency that should be placed in

strategic points within the city. Moreover, easy access to navigate through the Internet, either from a desktop PC, laptop or a smartphone, provides first hand through an application, the status of the different variables that they can be monitored on a volcano such as the status of its activity, amount and direction of pyroclastic flows.

## 2. ARTIFICIAL VISION APPLIED TO THE DETECTION OF LAVA AND SURFACES.

The main objective of digital image processing is find information within a matrix of pixels<sup>2,3</sup>, in this case is the pursuit of lava and pyroclastic flows within a sequence of images (video), captured through a sensor (camera) . The software used for digital processing stage, is Python, because of its features like: Speed, simplicity, order and especially most of the libraries needed to compile already are included, the other libraries must be installed from the terminal to command through.

### 2.1 IMAGES ACQUISITION

The images are captured by a camera attached to one of the USB ports (Fig 1), individually, sequentially or video<sup>3, 4</sup>. This camera is connected to a servomotor, which provides rotation in the visible range of the crater, and in the case of an eruption, keeps tracking of pyroclastic flows. Next stage is image digitalization, where catches become arrays of rows and columns with values for each pixel. Reading through programming it is done with the command`l`. Where cap is a storage array for images read by

the camera 0.

Command 1 video acquisition.

```
1 cap = cv2.VideoCapture(0)
```

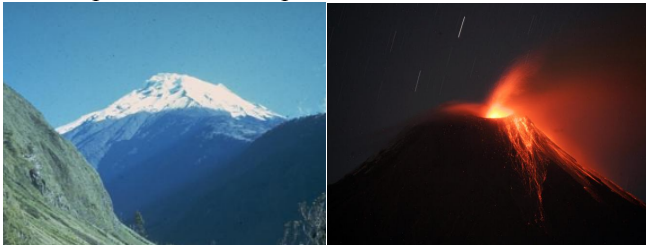

Fig 1. Snowy volcano Tungurahua (left), in eruptive process (right).

## 2.2 IMAGE PROCESSING AND DETECTION OF VARIABLES

After capturing the image, this is in the RGB color space (Red, Green and Blue), but for processing must be passed to HSV (Hue, Saturation and Value), command 2, because it facilitates the recognition of palettes specific between minimum and maximum values<sup>3,4</sup>, in addition to separating the layer brightness.

Command 2 conversion from RGB to HSV parameters

```
1 hsv = cv2.cvtColor(frame, cv2.COLOR_BGR2HSV)
```

Applying layers of erosion and dilation with command 3, to improve the morphology and better define the contours of an image. These things must be applied at least two or three times to get a better definition of the edges of an image.

Command 3 Application of layers of erosion and dilation

```
1 im=cv2.erode(im, cv2.getStructuringElement)
```

```
1 im=cv2.dilate(im, cv2.getStructuringElement)
```

To improve the image is necessary a Trackbar (Command 4) to modify the maximum and minimum HSV parameters<sup>5,7</sup>, those values will be used to create a mask (Command 5), which will function as a filter allowing passage only nuances in a set range, this range will consist of shades of lava and pyroclastic flows. Finally through another window the result of the binarized image (Command 6) is displayed and in white color is indicated the area to be the variable to be measured<sup>6-7</sup> and also indicate the presence of lava or pyroclastic flows (Fig. 18).

Command 4 Creation of Trackbar

```
1 cv2.createTrackbar('Hmax', 'Config', 0, 256)
```

```
2 cv2.createTrackbar('Hmin', 'Config', 0, 256)
```

```
3 cv2.createTrackbar('Smax', 'Config', 0, 256)
```

```
4 cv2.createTrackbar('Smin', 'Config', 0, 256)
```

```
5 cv2.createTrackbar('Vmax', 'Config', 0, 256)
```

```
6 cv2.createTrackbar('Vmin', 'Config', 0, 256)
```

Command 5 Mask with max and min HSV values - Tckb

```
1 im=cv2.inRange(hsv, np.array((Hmin, Smin, Vmin)),  
np.array((Hmax, Vmax, Smax)))
```

Command 6 Show the binarized image

```
1 cv2.imshow('inRange', im)
```

The state of eruption of the volcano will be considered active when in the binarized image exists a white area of over 500 pixels (Command 7), which would evidence detection pyroclastic flows or lava<sup>7</sup>.

Command 7 Detection of the area of interest inside 'im'

```
1 M=cv2.moments(im)
```

```
2 If M['m00']>10000:
```

## 3. ALARM AND COMMUNICATION SYSTEMS

One of the key parts for early warning to the surrounding communities of a volcano and to prevent risks that could cause an eruption<sup>8</sup>, are visual alarms placed in strategic locations and areas of high visibility for communities and high-risk sectors.

For sequential operation of eruption process detection and alarm activation, after detection of an area of interest in 'im' is necessary program GPIO ports and configure them as outputs.

Command 8 Configuration of GPIO ports as output

```
1 GPIO.setup(15, GPIO.OUT)
```

```
2 GPIO.setup(16, GPIO.OUT)
```

Control ports are operated by programation through the following command

Command 9 for control of GPIO ports

```
1 GPIO.output(15, True) # on
```

```
2 GPIO.output(16, False) # off
```

### 3.1 VISUAL ALARMS

They are observed directly, as LED lights or in a massive case the GPIO port could be connected to a potency system through a relay (Fig 2), whose electrical diagram is detailed in the following scheme.

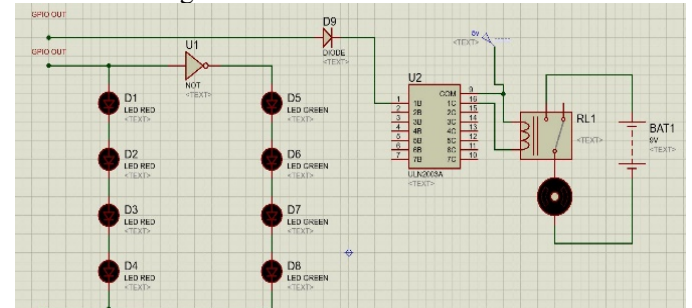

Fig 2. Electrical connection scheme.

#### 3.1.1 LIGHTING SYSTEM

The first part of the circuit Fig 3, are the LED visual alarms, same as have two states, on - off, whose colors are red and green, respectively indicating states of security and rash. For control is necessary only one GPIO port configured as a digital output, in order to avoid using multiple ports, turning slow processing when sending signals to the pins. In that place and to optimize resources and ports is imperative improved electronic design through the use of logic gates<sup>9,10</sup>, which only invert the signal, achieving the desired outputs through a single pin.

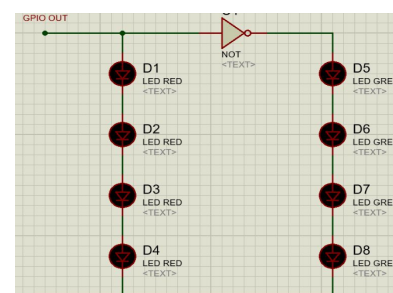

Fig 3. LED connection diagram.

3.1.2 APPLICATION FOR SMARTPHONE AND PC

The creation of the channel for subscription must be made in the "http://www.pushetta.com/" page, where the creation of an account is required and then add a channel and insert an image for identification, give properties that is public and a message to display (Fig 4).

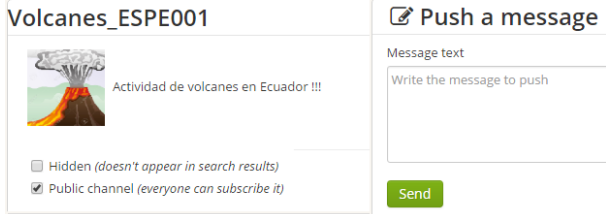

Fig 4. Creating the channel in the Pushetta page.

First of all to receive real-time notification alert monitored volcano eruption, you need to download a free app from the Play Store for Android and iOS App Store, called "Pushetta". Then is necessary a subscription to the monitoring previously created channel called "Volcanes\_ESPE001".

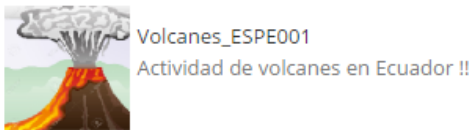

Fig 5. Capture, Channel Subscription.

In addition, monitoring can be performed directly from the website "http://www.pushetta.com/", performing the same subscription. The result is a real-time alert status of the volcano active if the eruptive process existed (Fig 12).

3.2 SOUND ALARM

A port is configured as a digital output, to a 2N222 transistor whose configuration is common emitter<sup>10,11</sup>, it serves to amplify the output current and simultaneously works as a switch when entering the zone of saturation, allowing the closure of the circuit and relay activation. The current emitted by a GPIO port is 16mA which is insufficient to directly activate a 5V DC motor or turn a relay on. To determine if the transistor enters the saturation zone is necessary to calculate the base current  $I_B$ , which should be greater than the relationship between the collector current  $I_C$  and gain  $\beta$  of the transistor 2N2222:

$$I_B > \frac{I_C}{\beta} \tag{1}$$

Where:

$$I_B = \frac{V_{CC} - 0.7V}{R1} \tag{2}$$

$$I_B = \frac{5 - 0.7V}{2.2K}$$

$$I_B = 1,95 [mA]$$

$$I_C = \frac{V_{DD}}{R2} \tag{3}$$

$$I_C = \frac{5V}{100}$$

$$I_C = 0,05 [A]$$

Analyzing the relationship:

$$I_B > \frac{I_C}{\beta}$$

$$1,95 mA > \frac{0,05A}{150}$$

$$1,95mA > 0,33mA$$

Concluding that the values of resistors Figure 6 (R1, 2.2k $\Omega$  & R2, 100  $\Omega$ ) and the transistor 2N2222, when applying a pulse up through the control pin, the transistor will enter the saturation zone<sup>9, 11</sup> activating the relay and the power stage.

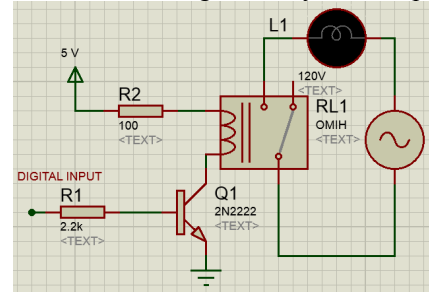

Fig 6. Current gain scheme and uncoupling of the control part and power.

3.3 COMMUNICATION SYSTEMS

The types of communication that can be used for data transmission, applicable to the project are: Bluetooth, Ethernet (html) through Wi-Fi, LAN, 3GSM and 4G LTE networks allowing interaction with the external environment<sup>12</sup> for monitoring eruptive process if there are. The main advantages of using a html communication on the Bluetooth is the global reach it generates to send data to a server, which can be accessed from anywhere in the world. To solve the problem of wiring and routers which in remote areas hardly be achieved, there are mobile networks such as LTE 4G or 3GSM to which can be accessed through modems mobile operators in the country because they have extensive coverage to areas remote access and provide internet access<sup>12, 13</sup>, depending on the area, there will be more or less coverage and that will depend on access to 4G LTE or 3GSM network. Where the main advantage of 4G over 3G network is the speed of data transfer that is approximately 80Mbps and 7.2Mbps for each network respectively<sup>14</sup>.

We could get access to internet from a modem, whose coverage extends to all parts of the area where network coverage is found, in case of areas surrounding volcanoes coverage has a range of about 80km, enough distance to keep informed the residents. Other hand the use of a LAN connection has high speed data transmission of 10Mbps but has a limit on coverage ranging from 200 meters and a maximum of 1 Km<sup>15</sup>. Being insufficient to cover a whole population.

4 EXPERIMENTAL RESULTS

4.1 IMAGES ACQUISITION AND PROCESSING.

For processing images can be acquired sequentially through a video camera Fig 7 or individually through a file format jpg or png Fig 8.



Fig 7. Video capture



Fig 8. Image format jpg

Mask created with the maximum and minimum values of Trackbar Fig 9, allows the passage of only the colors set in the range of Color shades. This is shown in Figure 10, the result of processing applied to Fig 8. Where you can see a volcano in eruption process emitting pyroclastic flows and volcanic lava.

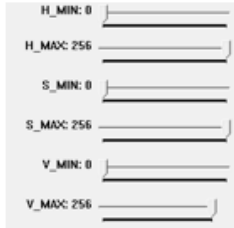

Fig 9. Trackbar



Fig 10. Processed image

After detection blank area of over 500 pixels (considered as rash), alarm systems are activated (Fig 11), red LEDs indicate status active volcano and Fig 12. Notification sent.



Fig 11. Indicative leds

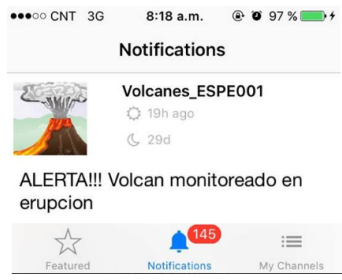

Fig 12 Notification received on iOS

Table. 1. Testing time delays to trigger alarms

Test	Time- turn on lights	Time - get notification	System Efficiency
Effective time / # test	0.5 s	12 seconds	100%
1	0.601 s	12.3 s	96.8%
2	0.700 s	12.6 s	93.9%
3	0.721 s	14.1 s	84.4%
4	0.650 s	12.5 s	95.05%
5	0.553 s	12.9 s	92.93%
6	0.768 s	13.3 s	88.9%
7	0.750 s	12.9 s	92.04%
8	0.767 s	13.5 s	87.6%
9	0.733 s	12.8 s	92.2%
10	0.690 s	12.6 s	93.0%

The efficiency of the alarm system is 92 percent (fig 13), this result was gotten based on random tests taken at intervals of 1 hour in continuous operation of the system. And the optimal times for turn on the light system is 0.5 seconds and to get notifications is 12s<sup>12, 14, 15</sup>.

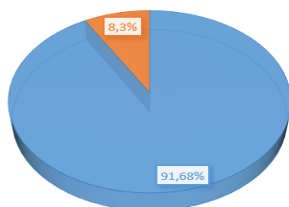

Fig 13. Percentage efficiency of the system based on table1

## 4.2 SERVO MOTOR CONTROL FOR MONITORING

Controlling the servomotor based on tracking the center of the detected area, thus, a control on the x axis is set, for this it is necessary to compensate the error obtained through Equation 5. The control pulses (Fig 15) ranging from 0 to 12.5, scaling with respect to the range of 0 to 270 degrees rotated by the servomotor, is directly proportional where 30 degrees is the angle of view covering a compact camera corresponds a value of 1.3 pulses.

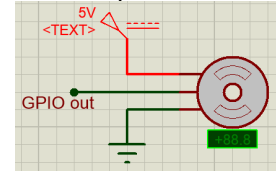

Fig 14. Servomotor Control, electronic connection

In order to obtain a mathematical model that dictaminates the error is established a proportionality between the pulses to send and the central position of the object detected measured in pixels within the window. Where 600 is the maximum number of pixels within the window and 1.3 is the maximum pulse to be sent.

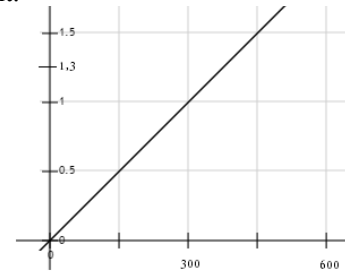

Fig 15. Pixels in window (x-axis horizontal) vs pulses to control the servomotor (y-axis vertical)

The equation is obtained through the linear model of equation 4 and the experimental data in Table 2. Where m is the slope obtained from equation 6, the points (x1, y1) corresponden value (600, 1.3) fig 15.

$$y - y_1 = m(x - x_1) \quad (4)$$

$$y - 1,3 = 0,0021(x - 600)$$

$$y = 1,3 + 0,0021x - 1,3$$

$$y = 0,0021x \quad (5)$$

$$m = \frac{y_2 - y_1}{x_2 - x_1} \quad (6)$$

$$m = \frac{1,3 - 0}{600 - 0}$$

$$m = 0,0021$$

The result of the equation ec5. Will be stored in a variable called "pul" which is what made the compensation, adding or subtracting a variable called "sol", this will send the number of resulting pulses to the port GPIO (command 10).

Command 10 Compensation and sending pulses - port

```

1  if(error > 200):
2      sol=sol-pul
3      p.ChangeDutyCycle(sol)
4  else:
5      sol=sol+pul
6      p.ChangeDutyCycle(sol)
    
```

Table 2. Error offset and pulses as tested

Error	Pulses*10 <sup>(-2)</sup>
220	46,2
210	44,1
330	69,3
250	52,5
344	72,24
232	48,72
160	33,6

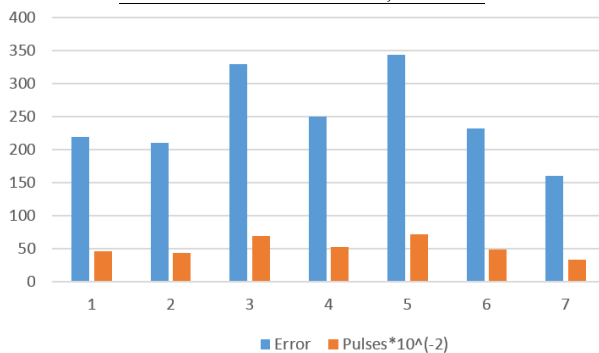

Fig 16. Pulse compensation based on errors obtained.

## 5. CONCLUSIONS

The centralization of the main plane of an eruption, that is the approach to the place of the volcano where there is greater amount of pyroclastic flows and volcanic lava, is an important aspect to have information about the direction in which these are to be moved. For monitoring made towards the center of the detected objects, compensation is employed by pulses sent to the anchored servomotor to a camera, using Equation 5 and Table 2 that dictate compensation pulse based on the obtained error displacement of the center screen relative to the center of the detected elements.

The warning systems such as light alarms, sirens, messages on mobile applications, which are transmitted in real time to vulnerable populations time, they can be vital to forewarn and especially save lives, because of the short time that used to be activated, in the case of lights and sirens of 500 milliseconds, the drive is immediate, because of the electronic control through which are actuated. While notifications takes about 12 seconds with an error of plus or minus 2 s, to arrive, using internet with 2.5 Mbps speed for the sender and the receiver. Showing that the system based on the tests performed has an efficiency of 90.03%, which can be enhanced if a better internet connection is used as fiber optics.

Free software used to perform the monitoring program (Python), was chosen for its low computational cost for processing and because it allows control of the GPIO ports. The program acquires images in RGB and processes them as matrices, such processing is to move the image to HSV, then apply several layers of erosion and dilation to improve, then through parameter setting HSV noise is eliminated, which is generated by

disturbances and camera sensor and choose only one winning specific shades of color known as "layer" which has the color gamut of volcanic lava and pyroclastic flows emitted by the volcano, the layers between HSV values are ( H min = 0, S min = 158 min = 108 V) and (H max = 256, S max = 188, V max = 256). Leaving only blank area of interest, which the area is calculated, and is considered significant if it is greater than 1000 pixels, because of the scaling 1-10000 for the mirror screen.

## ACKNOWLEDGMENTS

Sincerely grateful to the Universidad de las Fuerzas Armadas ESPE - Latacunga, especially to the engineer Dario Mendoza. To my mom, family and ceris. Thanks

## REFERENCES

- [1] M. S. M. v. W. S. e. a. Dueck, "Ethernet based time synchronization for Raspberry Pi network improving network model verification for distributed active turbulent flow control," *Control Theory Technol*, vol. 15, no. 204, 2015.
- [2] H. K. M. N. K. e. a. J. Sakaguchi, "Implantation of a newly developed direct optic nerve electrode device for artificial vision in rabbits," *Journal of Artificial Organs*, vol. 15, no. 97390, p. 295–300, 2012.
- [3] Y. W. P. P. Fangyan Nie, "Two-dimensional extension of variance-based thresholding for image segmentation," *Springer-Verlag*, vol. 24, no. 261, p. 485–501, 2013.
- [4] M. O. M. & A. R. J. F. Soltani, "Egg volume prediction using machine vision technique based in pappus theorem and artificial neural network," *Journal of Food Science and Technology*, vol. 52, no. 3454, p. 3065–3071, 2015.
- [5] Ö. & I. B. H. A. R. Erkent, "Artificial potential functions based camera movements and visual behaviors in attentive robots," *Springer US*, vol. 32, no. 15, p. 68, 2011.
- [6] A. F. A. O. G. e. a. Paolillo, "Vision-based maze navigation for humanoid robots," *Springer US*, vol. 17, no. 10.1007, 2016.
- [7] P. S. S. & K. A. J. Mahapatra, "Comparison Artificial Immune System and Particle Swarm Optimization and Techniques for Error Optimization Machine Vision Based Movements," *Journal of The Institution for Engineers: Series C*, vol. 96, no. 8150, p. 363–372, 2015.
- [8] G. L. A. C. Oscar Borla, "Piezonuclear neutron emissions from earthquakes and volcanic eruptions," *Meccanica*, vol. 50, no. 3454, p. 1651–1651, 2014.
- [9] U. G. D. Tehranipoor, "Counterfeit Integrated Circuits: Detection, Avoidance, and the Challenges Ahead," *Journal of Electronic Testing*, vol. 30, no. 6846, p. 9–23, 2014.
- [10] T. C. C. M. B. Poehls, "NBTI-Aware Design Integrated Circuits: A Hardware-Based Approach Increasing Circuits' Life Time," *Journal of Electronic Testing*, vol. 32, no. 25346, p. 315–328, 2016.
- [11] S. H. N. & L. J. Kim, "A broad-band V-band power amplifier using reduced access-resistance transistor layout in 65-nm CMOS," *Springer US*, vol. 82, no. 487, 2015.
- [12] J. G. K. R. D. Lloret, "Advances on Network Protocols and Algorithms for Vehicular Ad Hoc Networks," *Springer US*, vol. 18, no. 749, 2013.
- [13] P. Gutiérrez, "A Simplified Internet Routing Architecture," *Springer US*, vol. 16, no. 433, 2011.
- [14] R. R. R. & A. H. Attia, "Internet connectivity for mobile ad hoc network: survey based study," *Springer US*, vol. 21, no. 2369, 2015.
- [15] Y. W. C. C. H. Zhang, "Editorial for WICON 2010 on "Recent advances in wireless internet", " *Springer US*, vol. 16, no. 745, 2011.