



ESPE
UNIVERSIDAD DE LAS FUERZAS ARMADAS
INNOVACIÓN PARA LA EXCELENCIA



“Diseño y construcción de una plataforma móvil diferencial para la implementación de mapeo semántico”

Autor

Edisson Fabricio Cañar Ortiz

DIRECTOR DEL PROYECTO

Ing. David César Loza Matovelle

2022

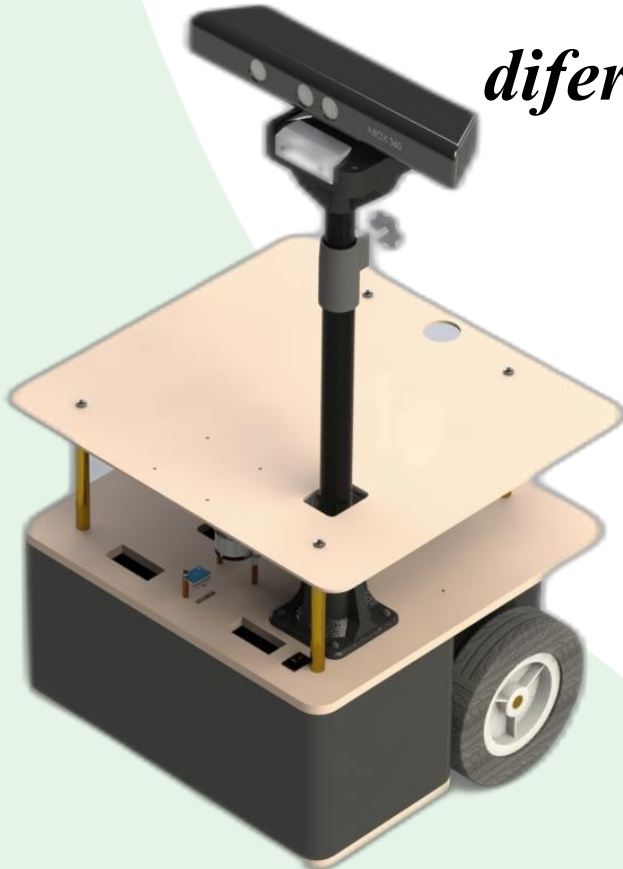



CONTENIDO

- Objetivos
- Justificación e importancia
- Estado del arte
- Diseño y construcción
- Pruebas y resultados
- Conclusiones, recomendaciones y trabajos futuros



Objetivo General

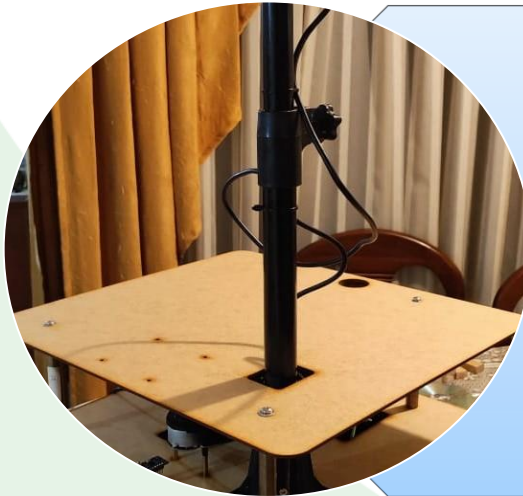

Diseñar y construir una plataforma móvil diferencial para la implementación de mapeo semántico.

Objetivos

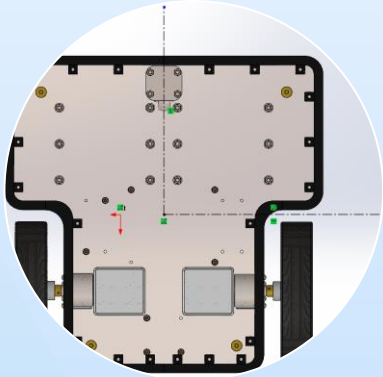

Plataforma
diferencial



Velocidad-
0,25 m/s

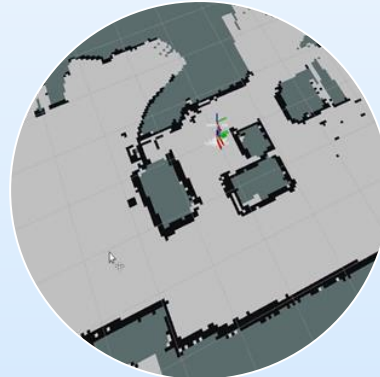

Odometría
y SLAM



Relacionar
objetos y
lugares



Mapa
Semántico-
Ontología





ESPE

UNIVERSIDAD DE LAS FUERZAS ARMADAS
INNOVACIÓN PARA LA EXCELENCIA



Justificación e Importancia



Interacción
Usuario-
Máquina



Aprendizaje
del robot



Mapa
Semántico



Mejorar
servicio





ESPE

UNIVERSIDAD DE LAS FUERZAS ARMADAS
INNOVACIÓN PARA LA EXCELENCIA



Estado del Arte

Percepción



Sensor Kinect

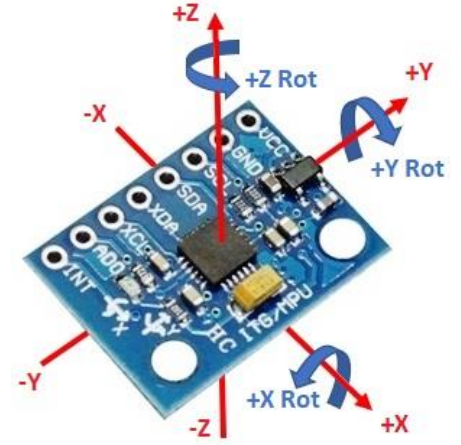
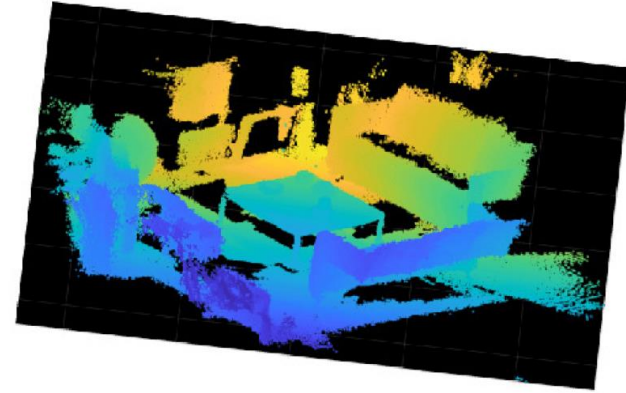

Sensor Inercial



Sensor Lidar

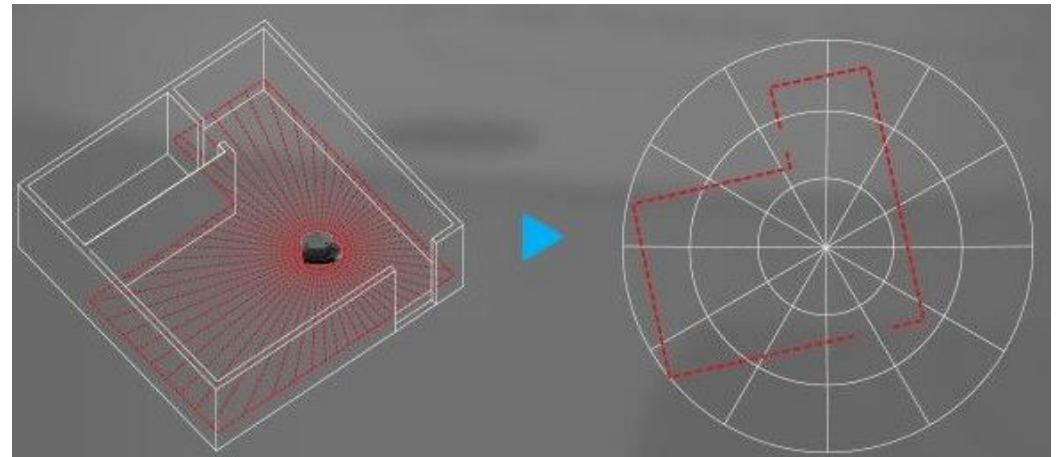

Localización

Dónde estoy?

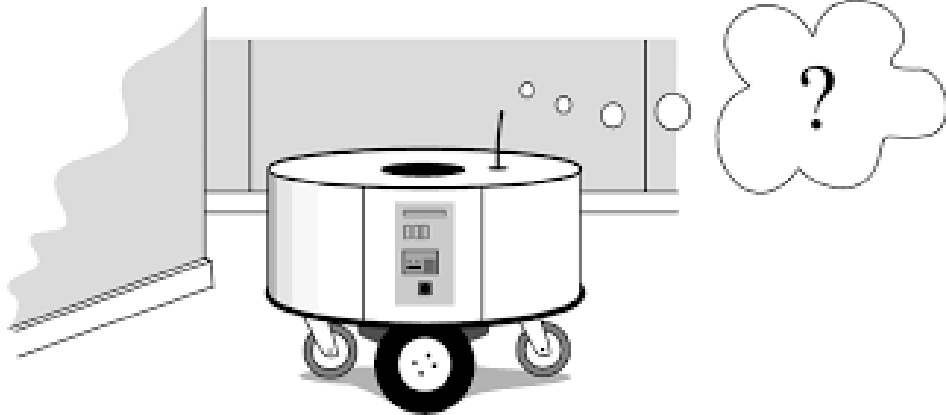

Odometría

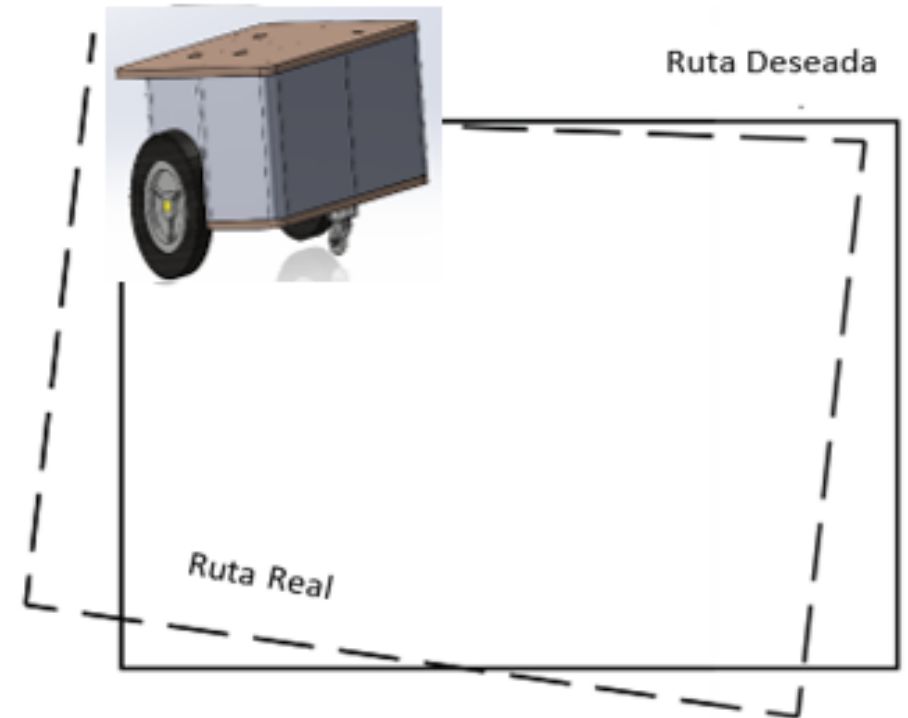



ESPE

UNIVERSIDAD DE LAS FUERZAS ARMADAS
INNOVACIÓN PARA LA EXCELENCIA



SLAM

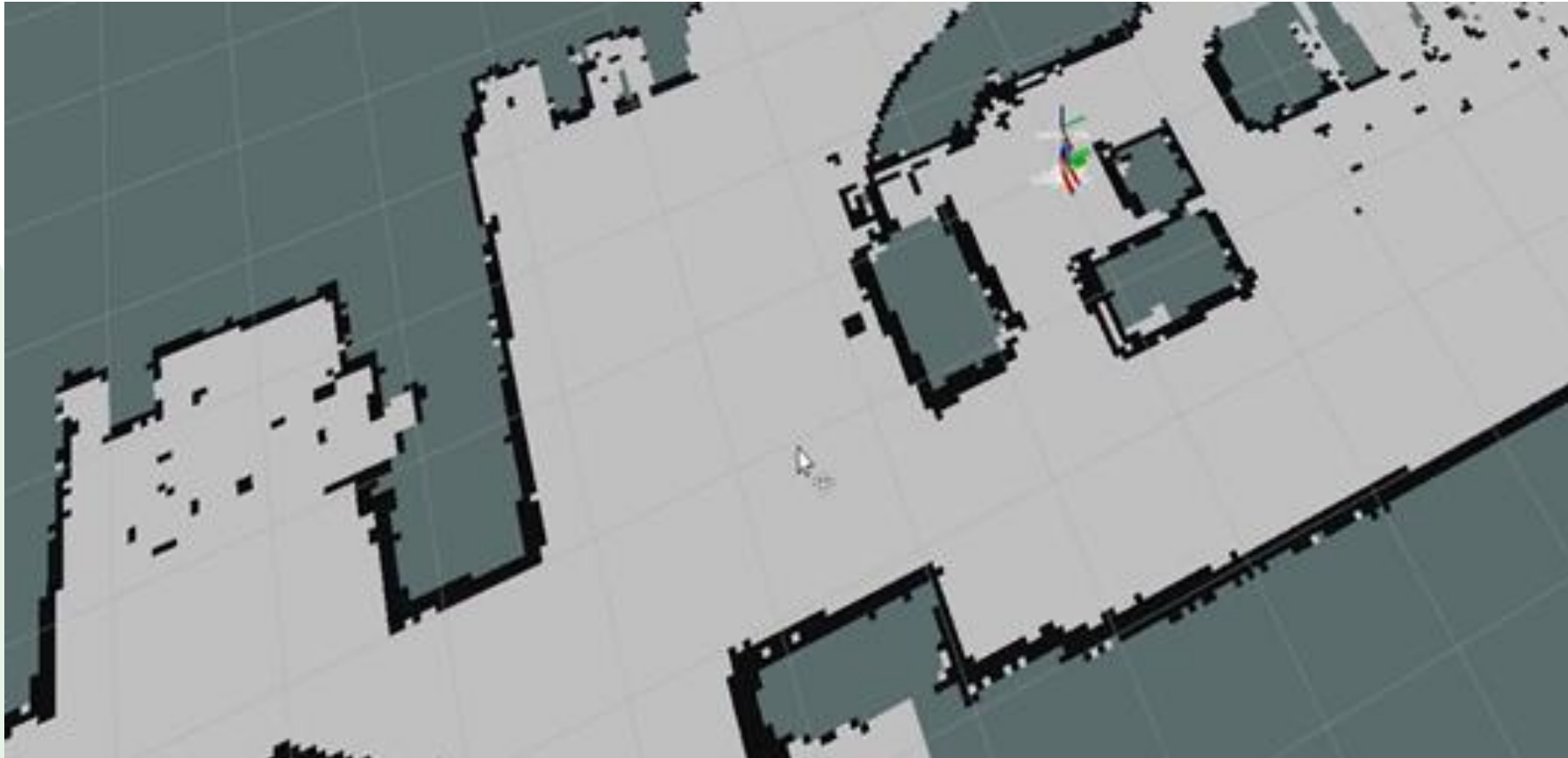

Mapa Semántico

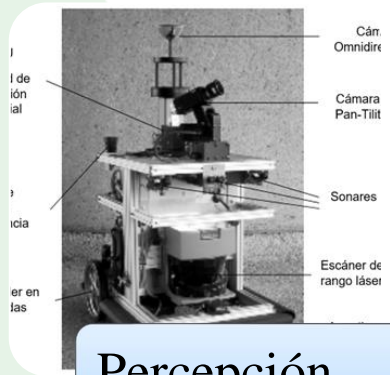

Percepción

- Información del entorno.

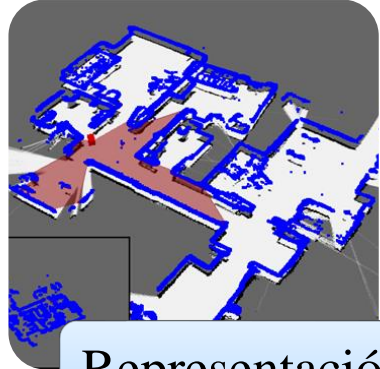

Representación

- Generación de mapas.

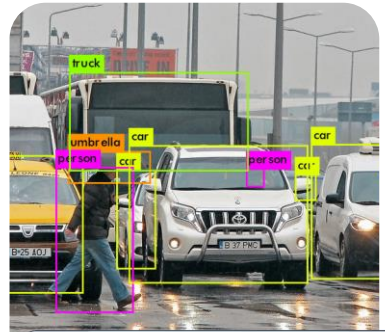

Conceptualización

- Detección de objetos.



Mapa Semántico

- Relacionar entidades con el mapa.



ESPE

UNIVERSIDAD DE LAS FUERZAS ARMADAS
INNOVACIÓN PARA LA EXCELENCIA



Diseño y Construcción



Características técnicas

N. de Métrica	Métrica	Magnitud	Unidad
1	Masa Total del robot	< 15	kg
2	Altura del robot	< 1.25	cm
3	Diámetro del robot	< 45	cm
4	Tiempo de ensamblaje	< 15	min
5	Velocidad de desplazamiento	$\leq 0,25$	m/s
6	Cantidad de Motores	2	unidades
7	Duración de Batería	> 30	min
8	Deformación del material en la base	< 2	mm
9	Tipo de código	Abierto	-----
10	Capacidad de baterías mínimo	>5	Ah

Subsistemas

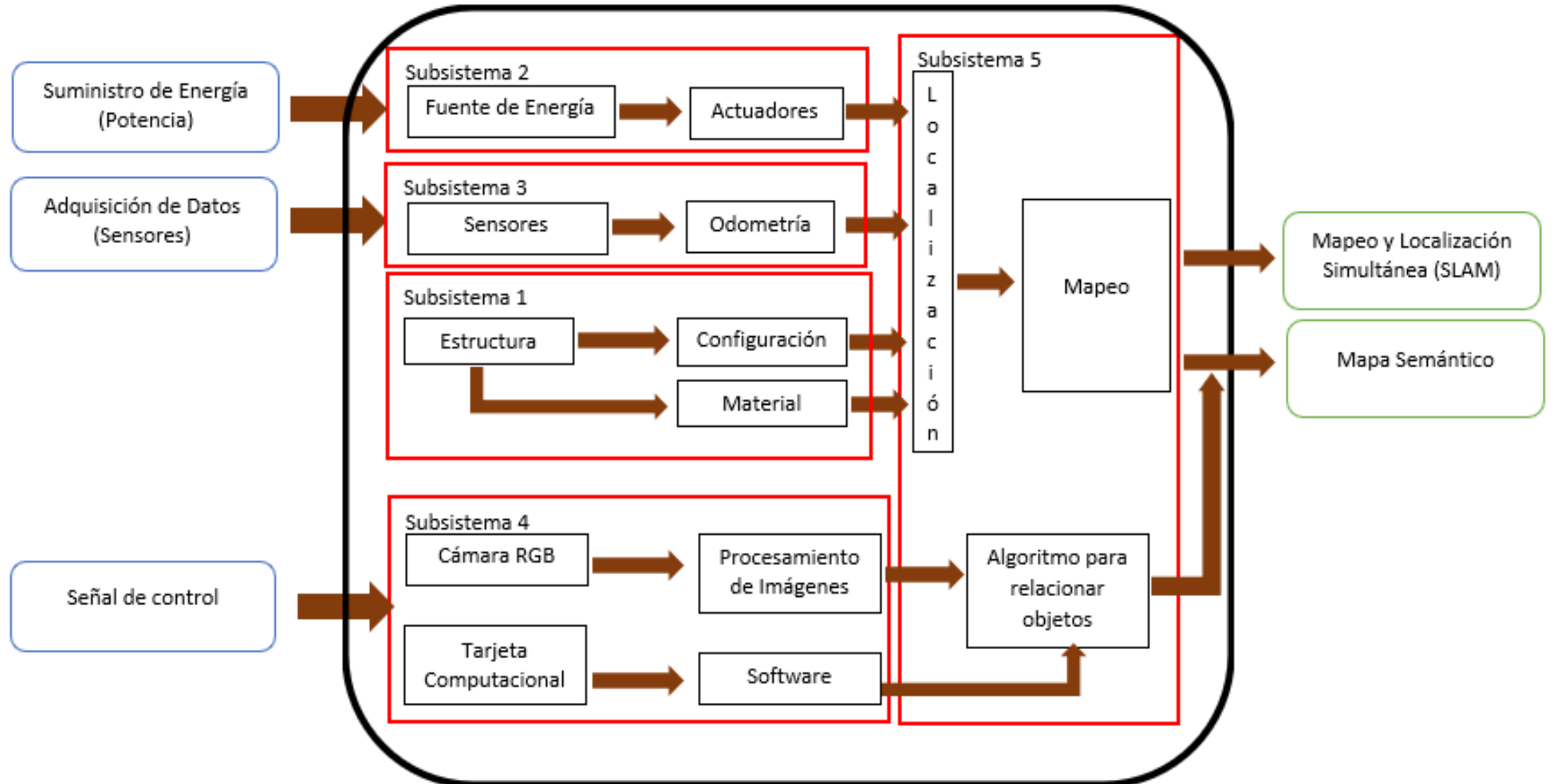



Módulos

Módulo	Subsistema
Estructura de la plataforma móvil	Estructura
Movilidad de la plataforma móvil	Potencia y Tracción
Funcionamiento de la plataforma móvil	Sensores
	Procesamiento y Detección
	Mapeo y Ontología



Etapas de desarrollo

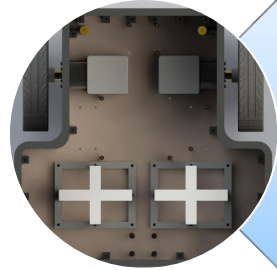

Módulo de la estructura

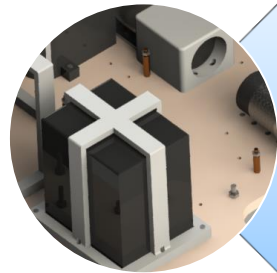

Módulo de la movilidad

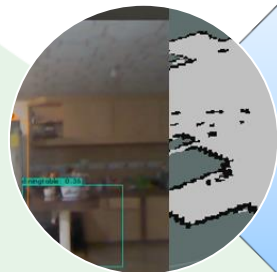

Módulo de la Funcionalidad

Resultado de selección

Módulo	Alternativa de Solución
Estructura de la plataforma móvil	
Movilidad de la plataforma móvil	  
Funcionamiento de la plataforma móvil	  



Etapas de desarrollo

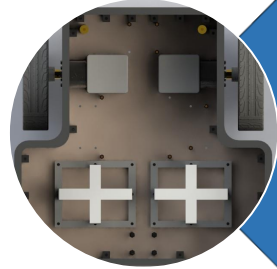

Módulo de la
estructura

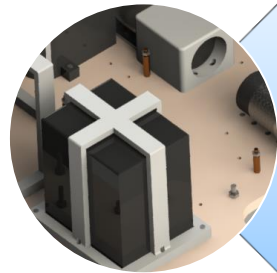

Módulo de la
movilidad

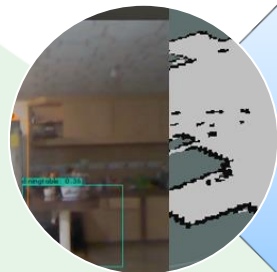

Módulo de la
Funcionalidad



ESPE

UNIVERSIDAD DE LAS FUERZAS ARMADAS
INNOVACIÓN PARA LA EXCELENCIA



Módulo Estructura

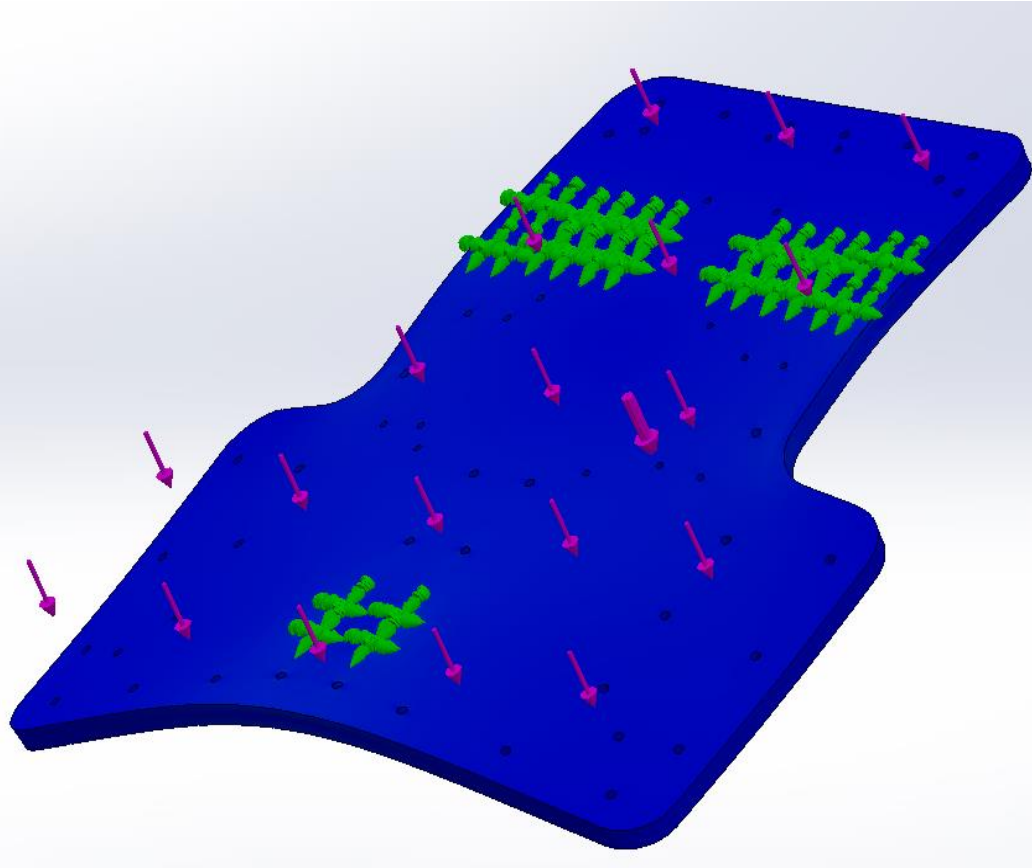

Módulo Estructura

Número	Descripción	#Elementos
1	Cubierta derecha delantera	1
2	Cubierta derecha posterior	1
3	Soporte secundario del motor	2
4	Cubierta izquierda posterior	1
5	Soporte para batería	1
6	Soporte de cobre	4
7	Cubierta Derecha Delantera	1
8	Rueda motriz	2
9	Base de MDF	1
10	Unión motor-rueda	2
11	Rueda loca	1

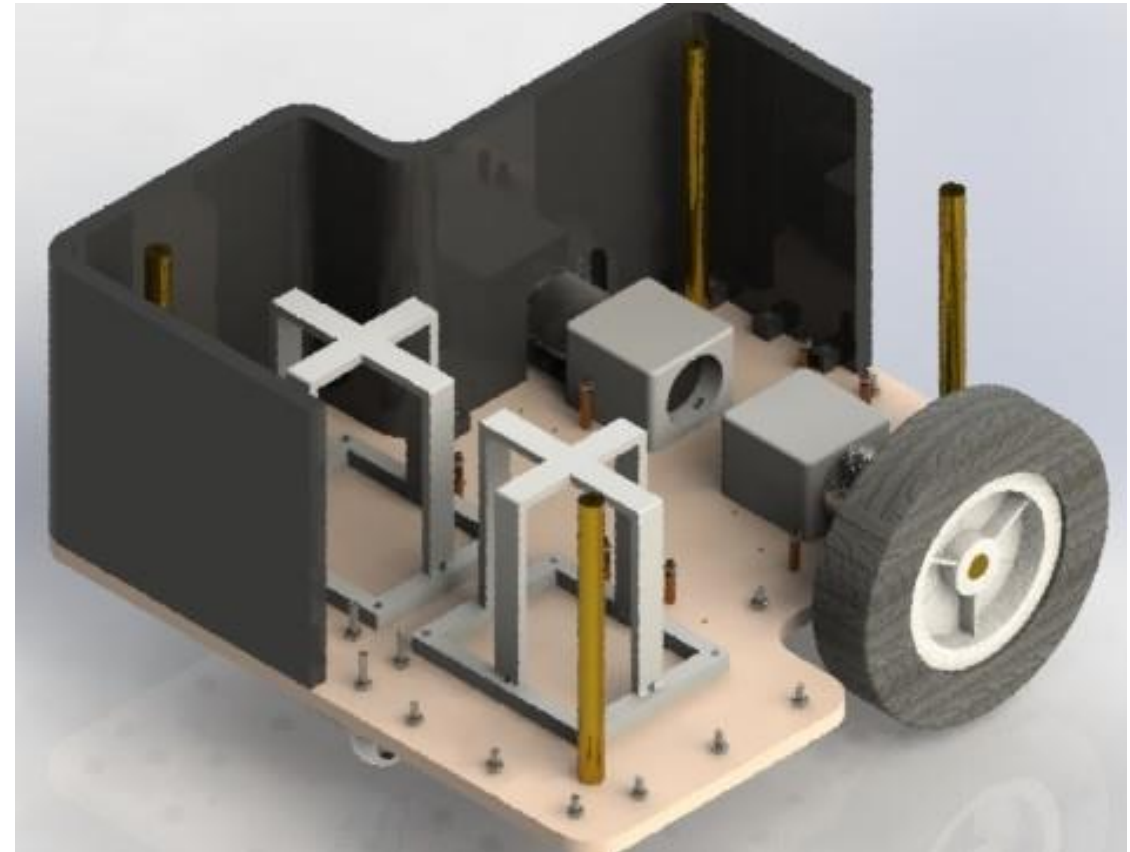



Módulo Estructura

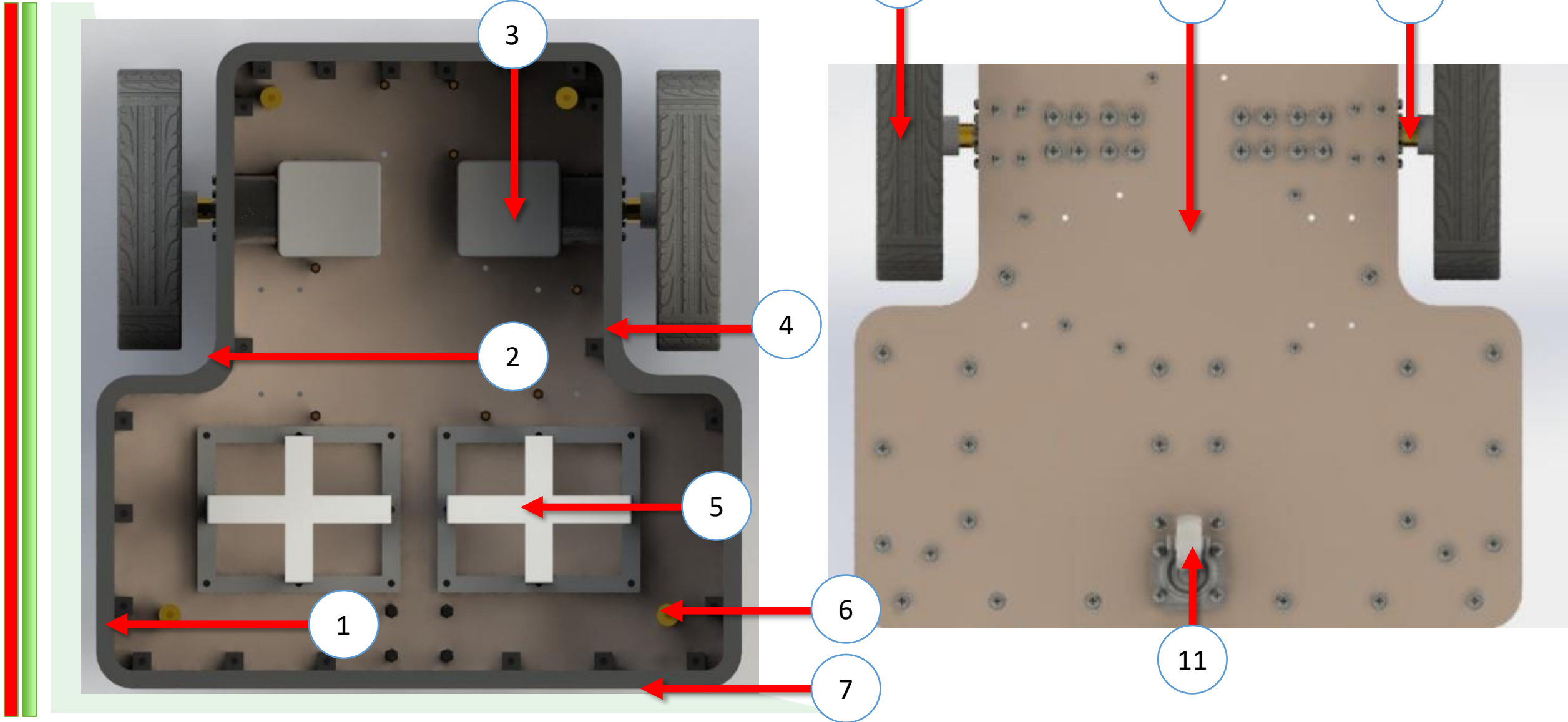



Etapas de desarrollo

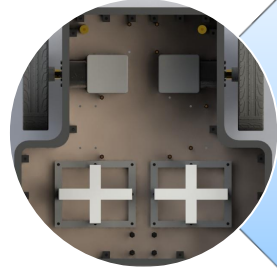

Módulo de la estructura

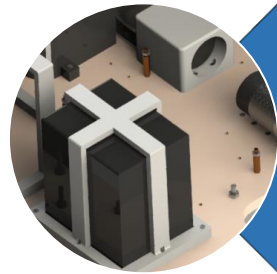

Módulo de la movilidad



Módulo de la Funcionalidad

Módulo Movilidad

Número	Descripción	#Elementos
1	Batería	2
2	Motor DC	1

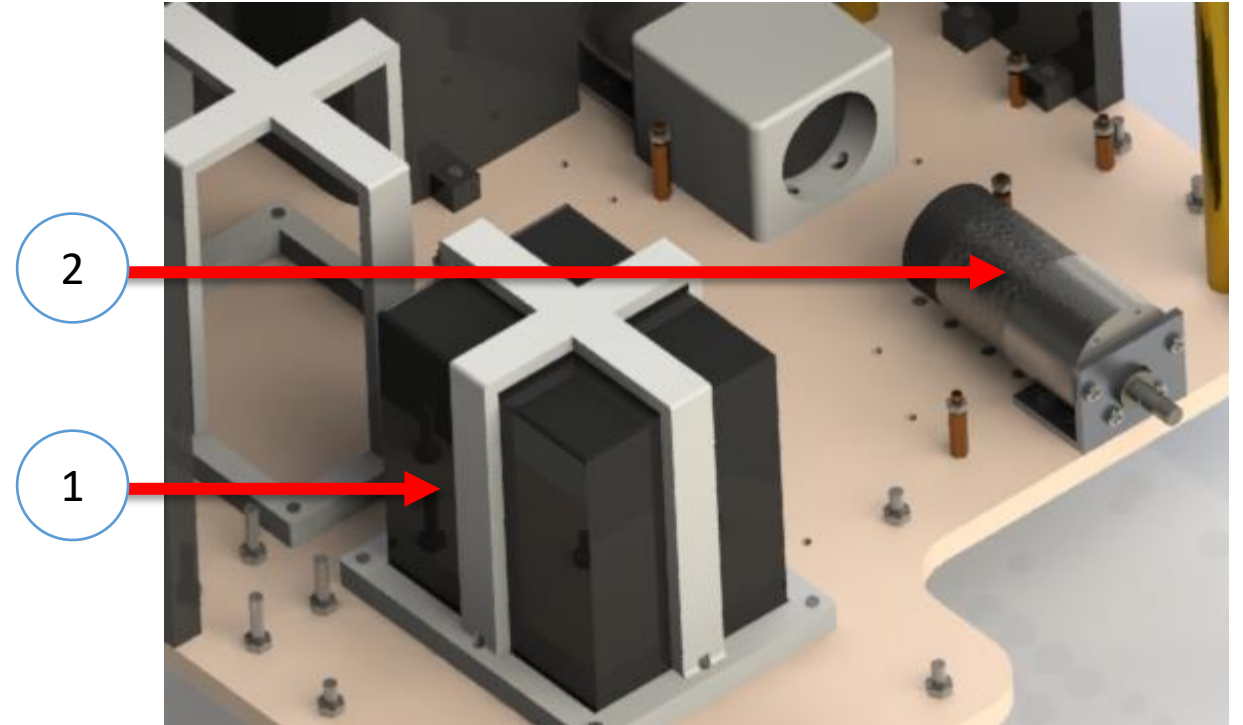

Módulo Movilidad

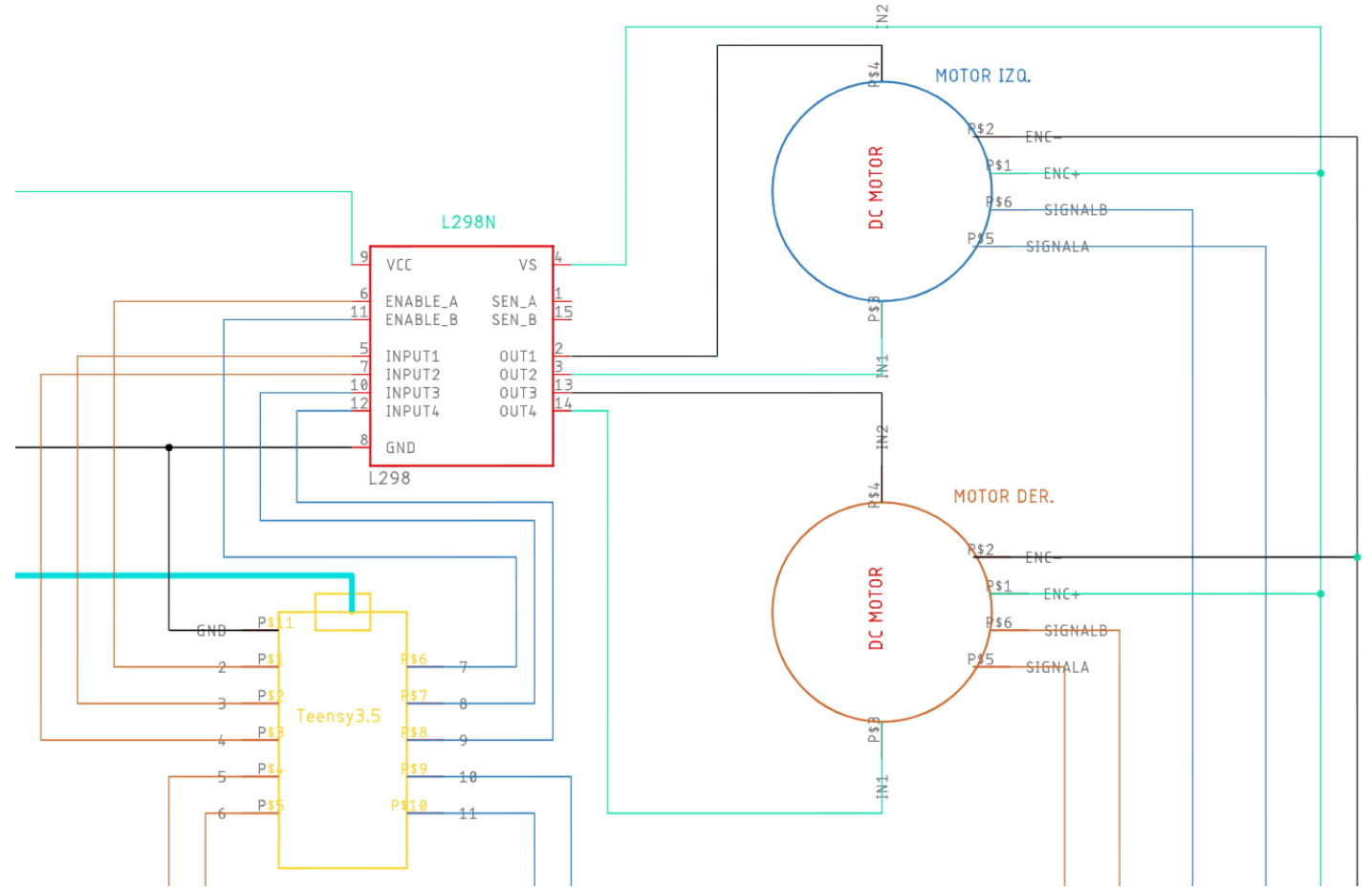
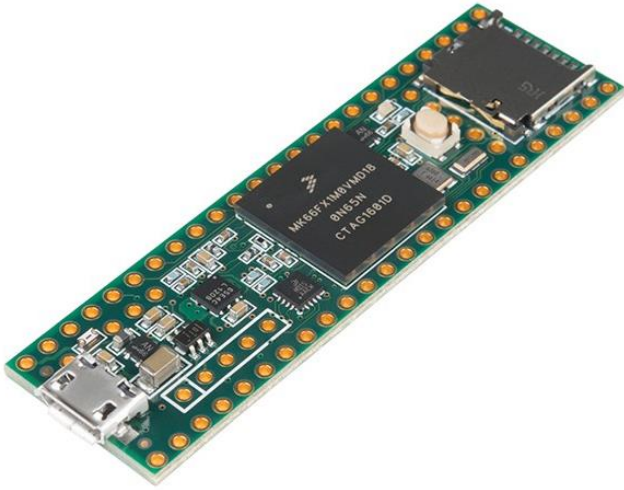



Etapas de desarrollo

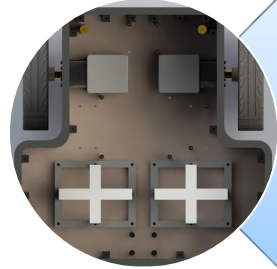

Módulo de la estructura

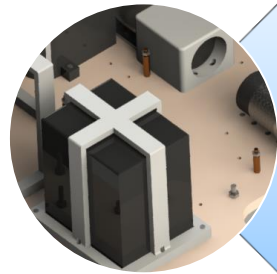

Módulo de la movilidad



Módulo de la Funcionalidad

Módulo Funcionalidad

Número	Descripción	#Elementos
1	LIDAR	1
2	Kinect	1
3	MPU-6050	1

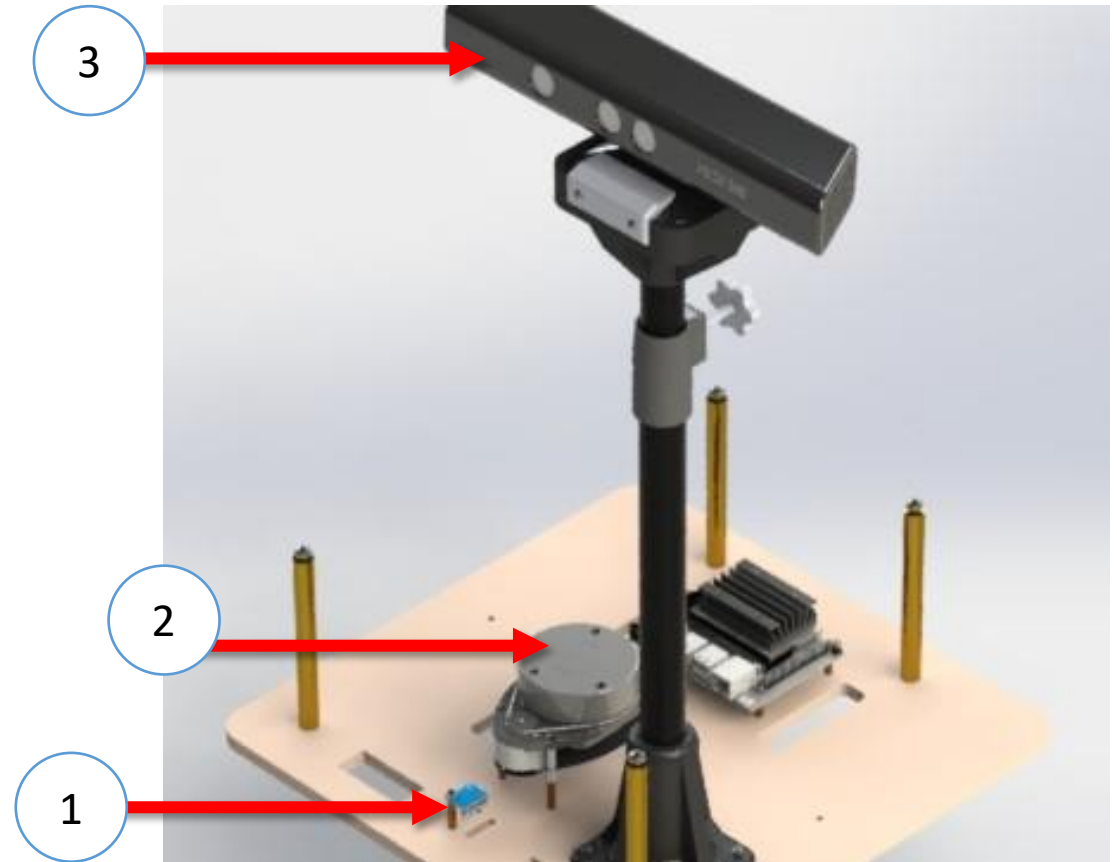



ESPE

UNIVERSIDAD DE LAS FUERZAS ARMADAS
INNOVACIÓN PARA LA EXCELENCIA



Módulo Funcionalidad

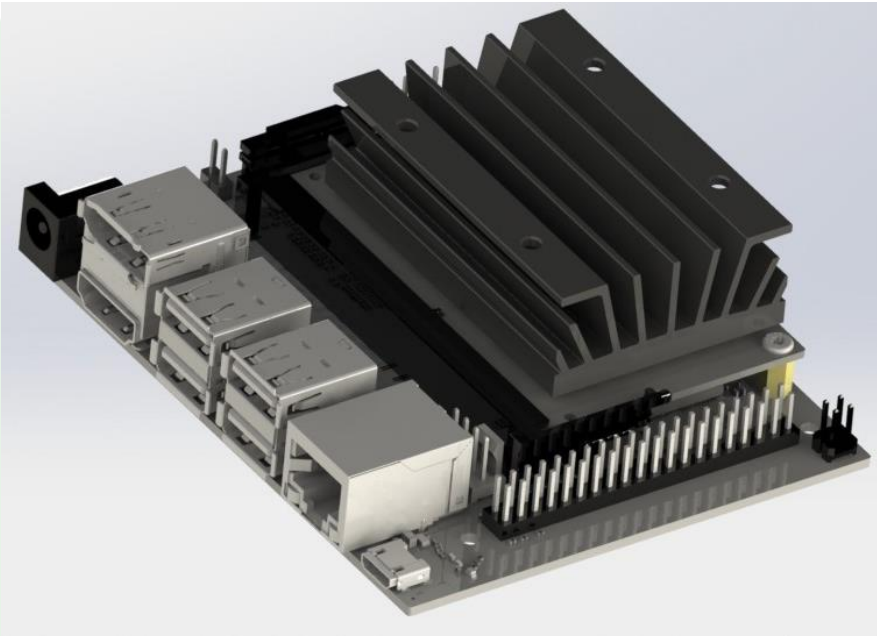

Jetson Nano 4Gb



 **ROS**
Robot Operating System



You Only Look Once

SLAM

Odometría

- Obtenido por el control sobre los motores.



Láser

- Obtenidos por el sensor Lidar.



SLAM-GMAPPING

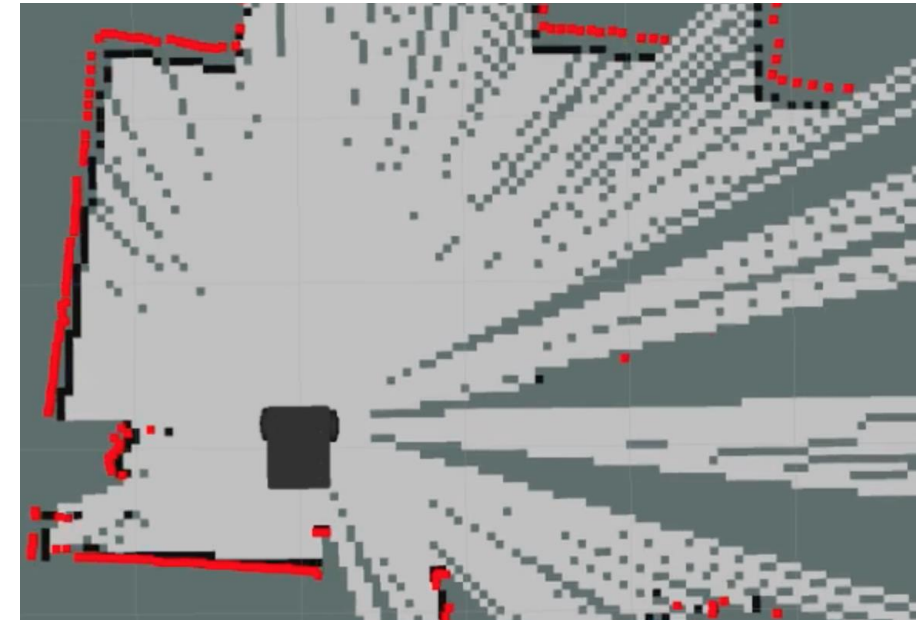

Módulo Funcionalidad

Detección de Objetos-YOLO

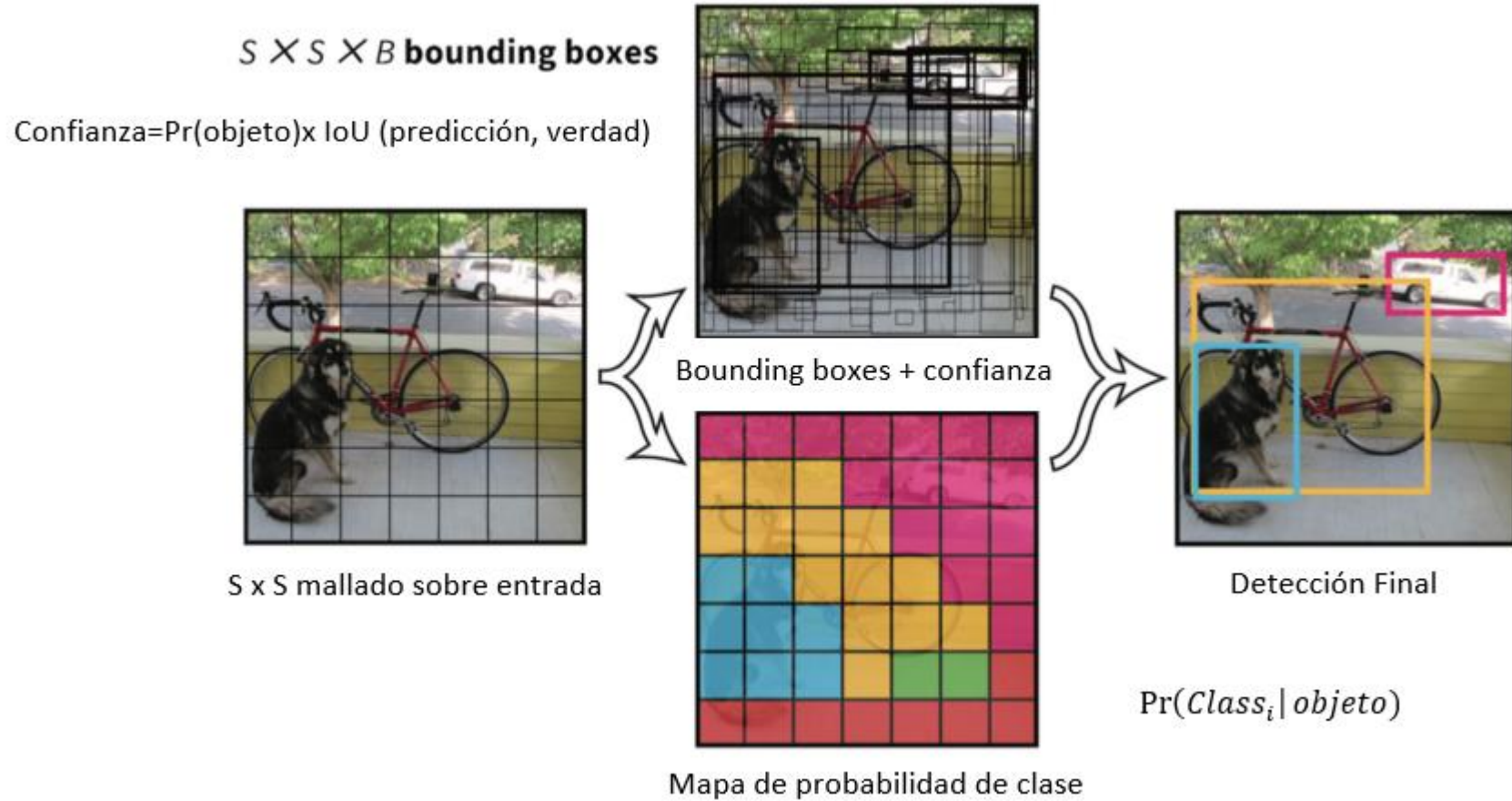

Construcción

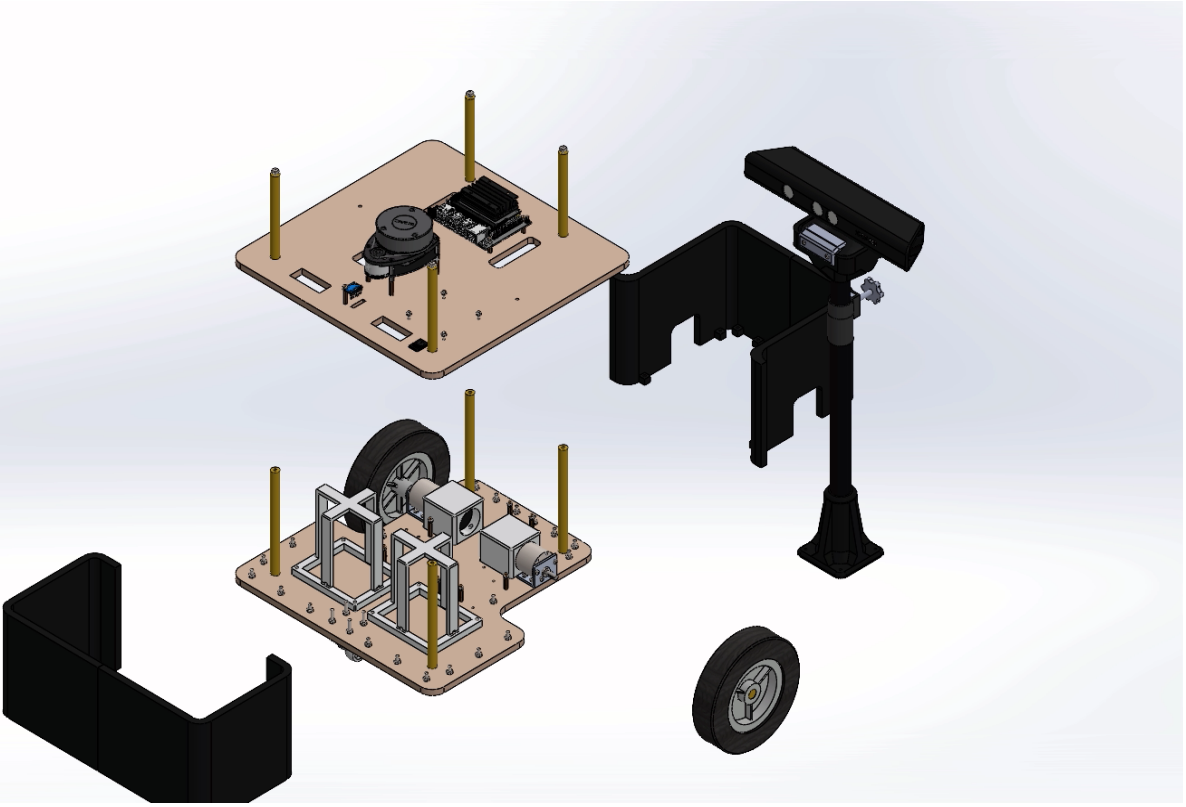
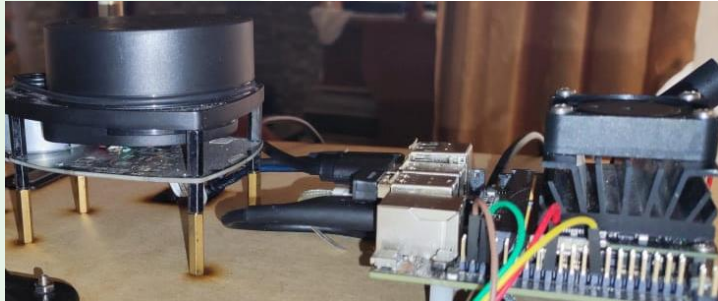
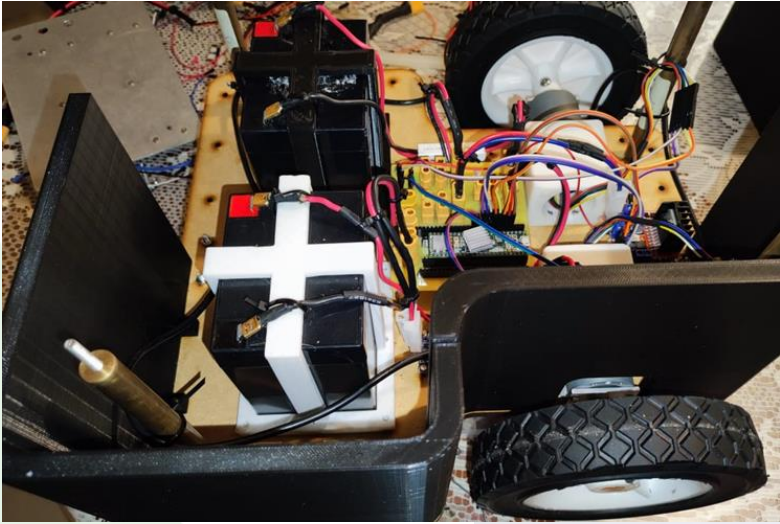



ESPE

UNIVERSIDAD DE LAS FUERZAS ARMADAS
INNOVACIÓN PARA LA EXCELENCIA



Pruebas y Resultados



Motor Derecho

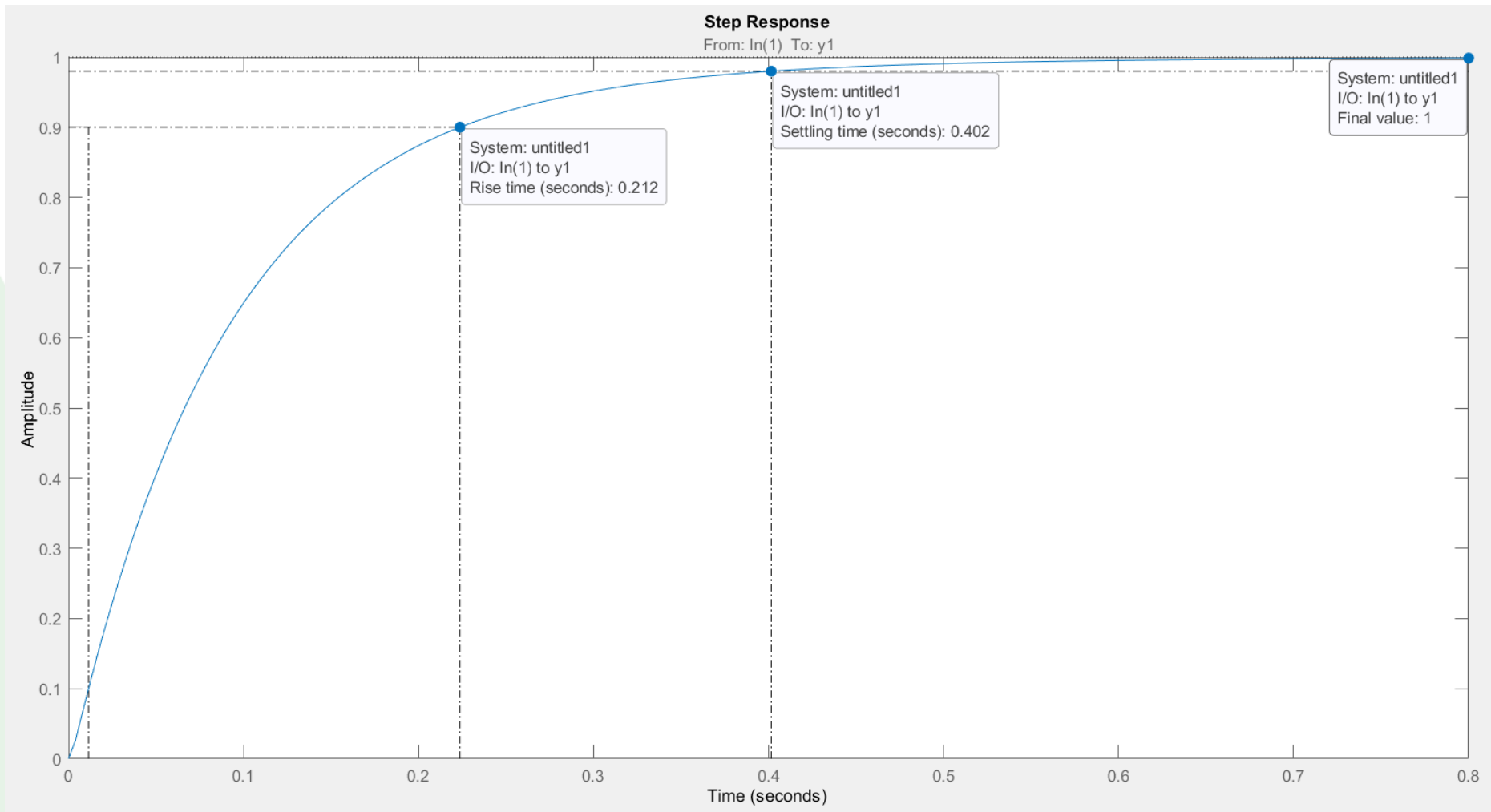



Motor Izquierdo

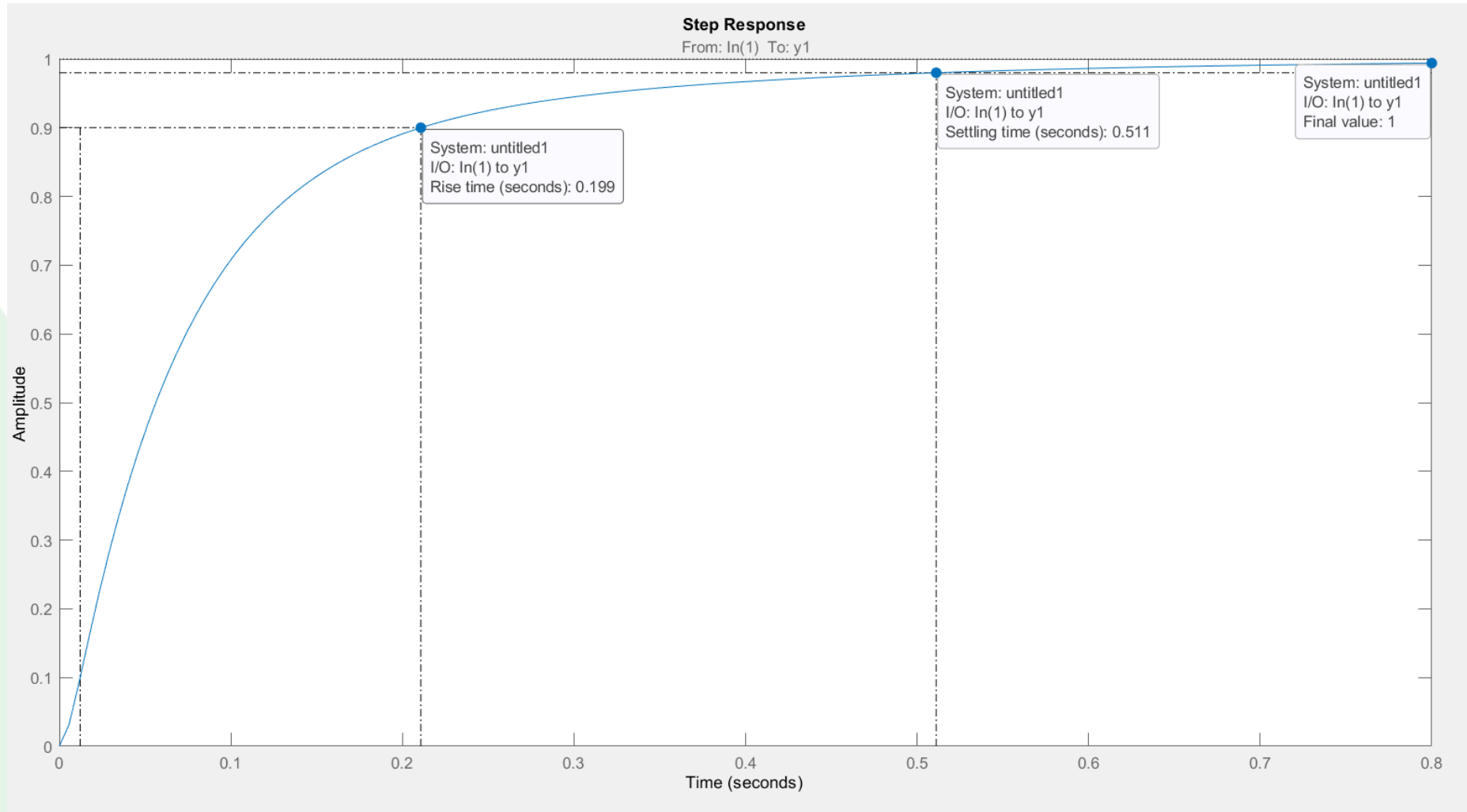



Prueba de Velocidad

V=0,15 m/s

Distancia (m)	Tiempo Real (sg)	Tiempo Medido	Error (%)
1	6,67	6,72	0,5
1.5	10	10,12	1,2
2	13,33	13,49	1,6

V=0,20 m/s

Distancia (m)	Tiempo Real (sg)	Tiempo Medido	Error (%)
1	5	5,18	0,8
1.5	7,5	7,66	1,6
2	10	10,23	2,3

V=0,25 m/s

Distancia (m)	Tiempo Real (sg)	Tiempo Medido	Error (%)
1	4	4,16	1,6
1.5	6	6,29	2,9
2	8	8,37	3,7

Prueba de Odometría

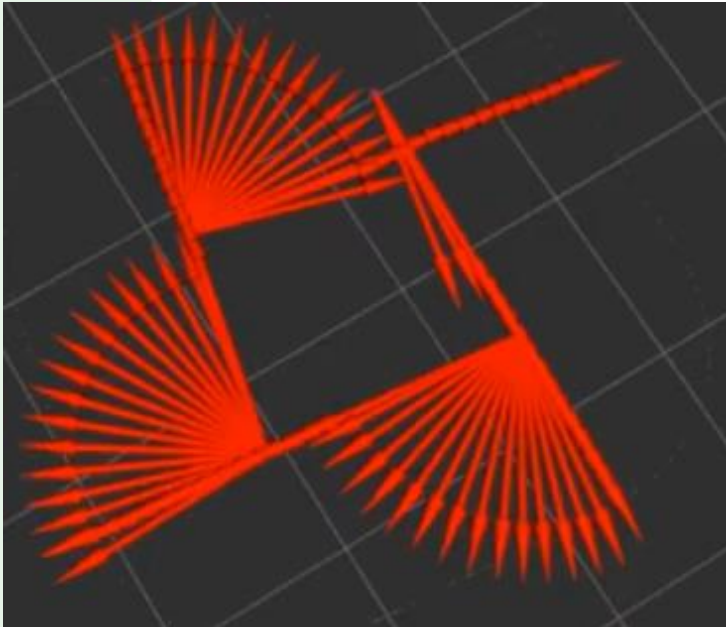
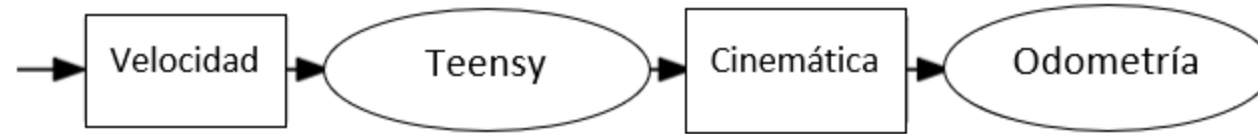

Puntos	P1	P2	P3	P4
X (m)	1,483	1,396	-0,037	0,055
Y (m)	0,005	1,521	1,474	-0,224
X deseado	1,5	1,5	0	0
Y deseado	0	1,5	1,5	0
Error en X (%)	1,7	10,4	3,7	5,5
Error en Y (%)	0,5	2,1	2,6	22,4

Prueba error de SLAM

Lado	Distancia		Error (%)
	Real (m)	SLAM (m)	
L1	2,48	2,51	1,21
L2	1,10	1,04	5,45
L3	1,98	2,06	4,04

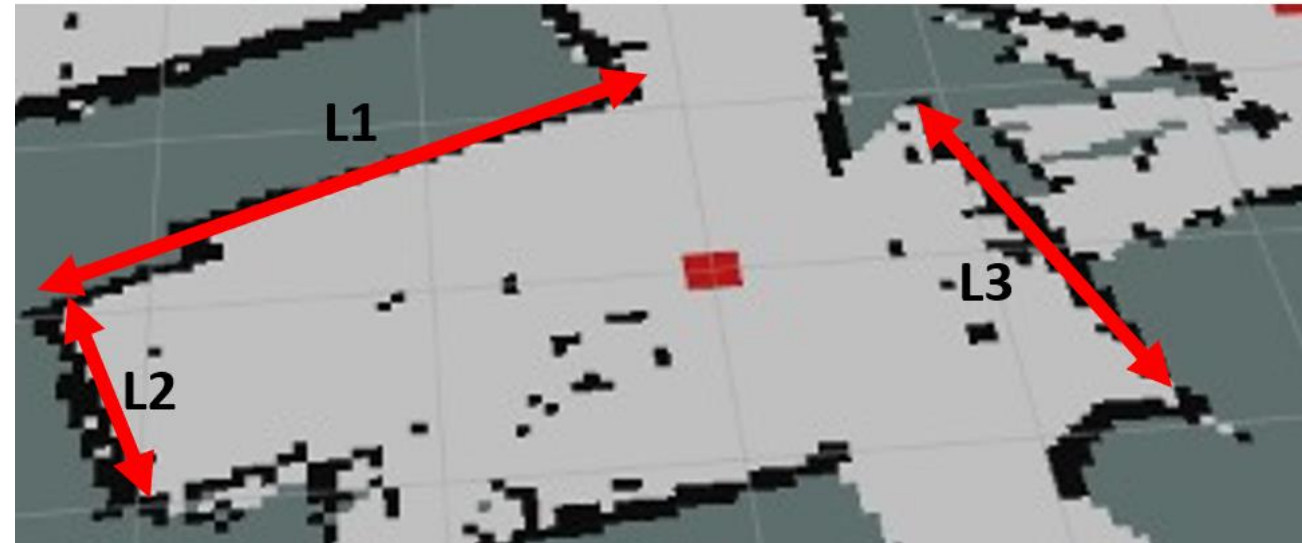

Prueba en Detección de Objetos

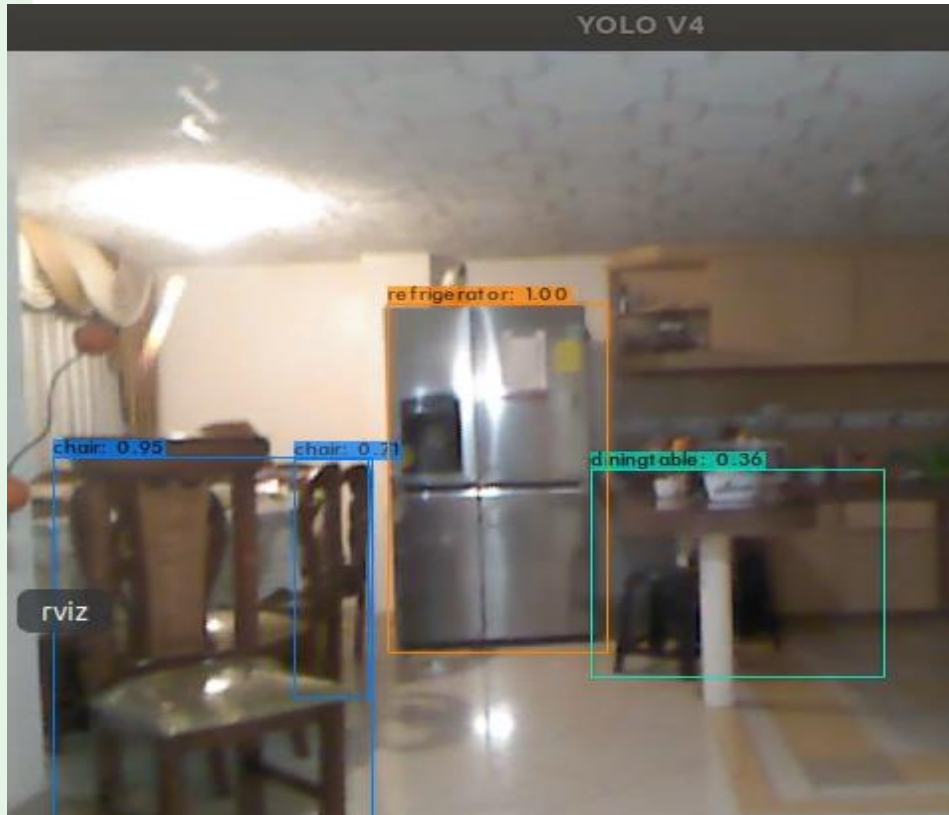

Objeto Real	Clase	Probabilidad (%)
Televisión	tvminitor	99
Persona	person	58
Cama	bed	93
Silla	chair	95
Mochila	suitcase	39
Armario	refrigerator	57
Sofá	bed	42

N de observaciones	Distancia		
	4 (m)	2 (m)	1 (m)
Objeto			
Televisión	4	5	5
Cama	2	4	5
Silla	3	5	5
Sofá	2	3	4
Refrigerador	3	5	5

Prueba de Mapa Semántico

Cuarto1		Cuarto2		Cuarto3		Cuarto4	
Obj. real	Obj. mapa	Obj. real	Obj. mapa	Obj. real	Obj. mapa	Obj. real	Obj. mapa
cama	bed1	cama	bed2	cama	bed3	horno	oven1
laptop	laptop1	laptop	-	laptop	laptop2	mesa	dinnigtable1
silla	chair1	silla	chair2	mesa	-	microondas	microwave1
televisión	tvmonitor1	televisión	tvmointon2	-	-	refrigerador	refrigerator1
						silla	chair3
4	4	4	3	3	2	5	5

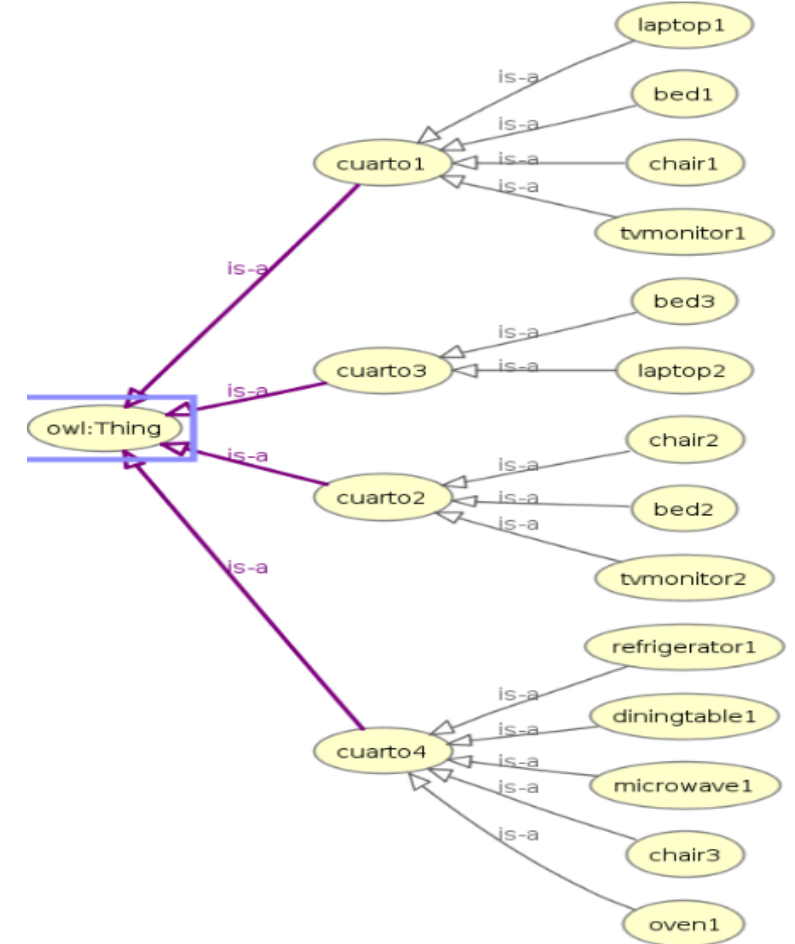



Resultados



ERROR EN VELOCIDAD

■ D=1 (m) ■ D=1.5 (m) ■ D=2 (m)

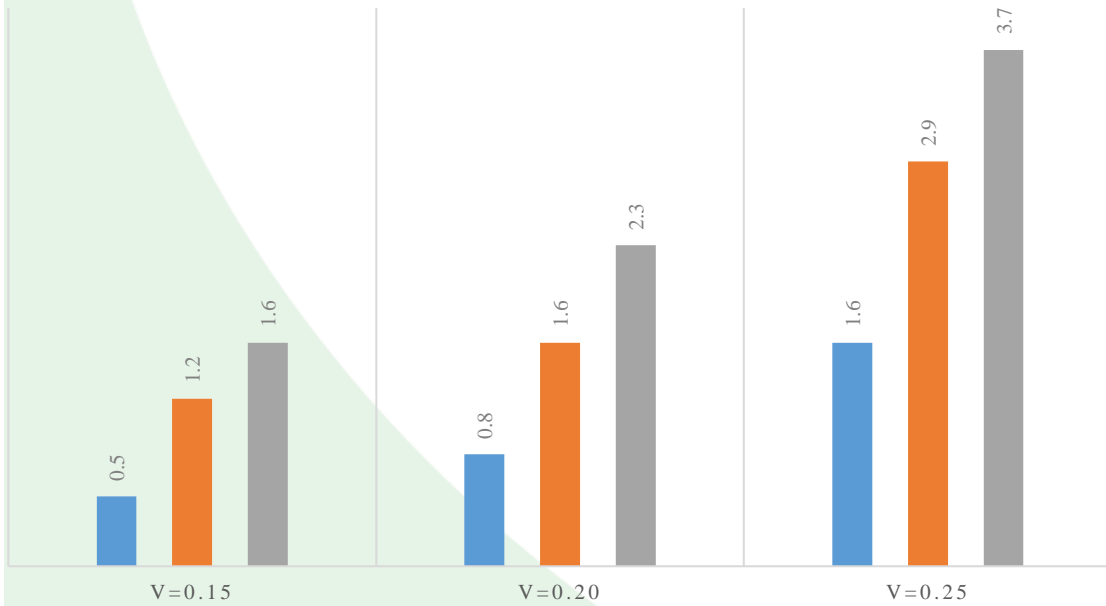

ERROR EN ODOMETRÍA

■ Error en X (%) ■ Error en Y (%)

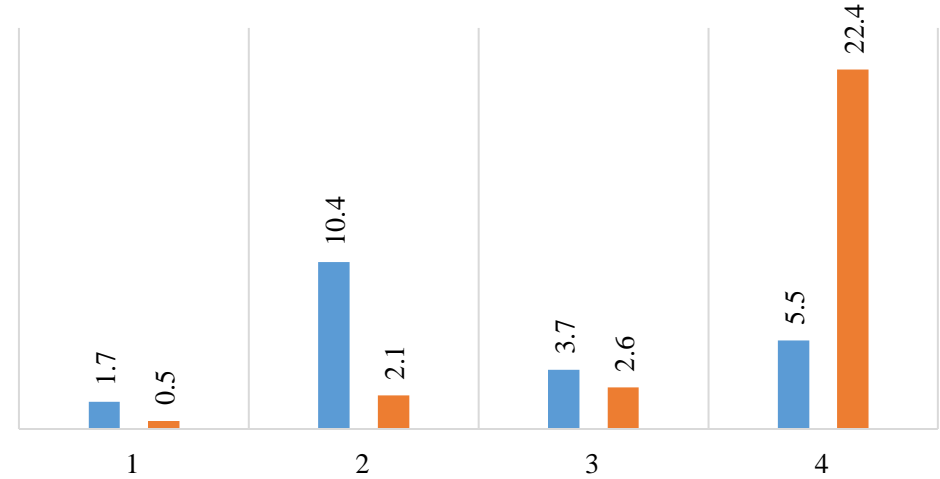

ERROR EN SLAM (%)

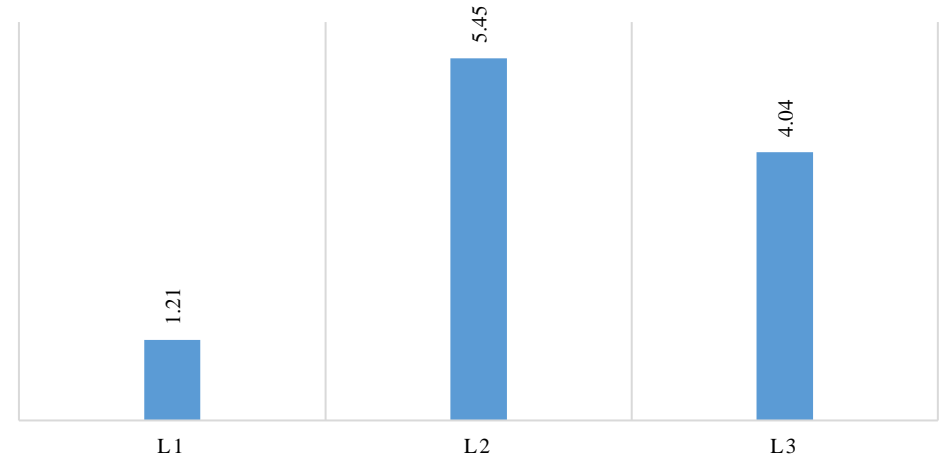



Resultados

PROBABILIDAD DE DETECCIÓN

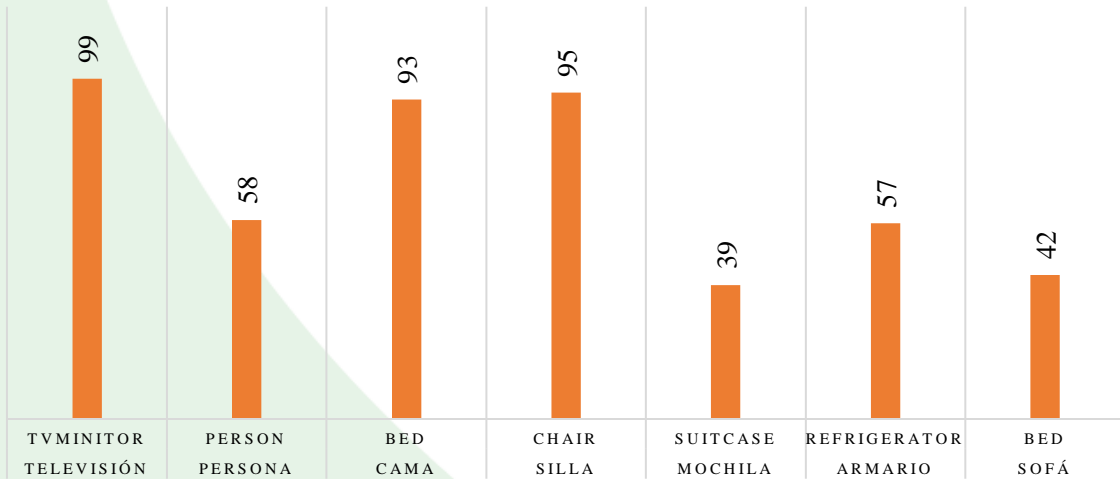

REPETIBILIDAD

■ 3 (m) ■ 2 (m) ■ 1 (m)

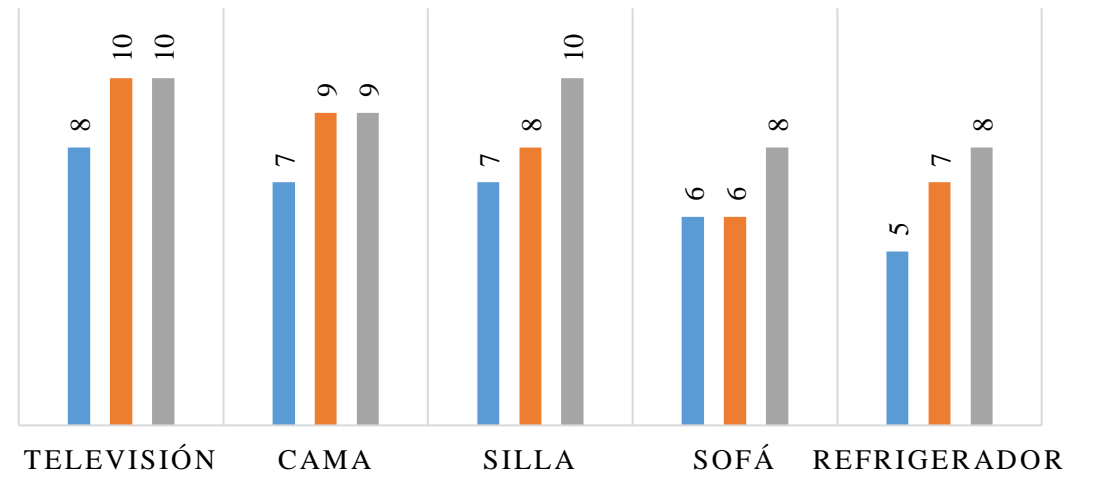



ESPE

UNIVERSIDAD DE LAS FUERZAS ARMADAS
INNOVACIÓN PARA LA EXCELENCIA



Conclusiones, Recomendaciones y Futuros Trabajos

Conclusiones

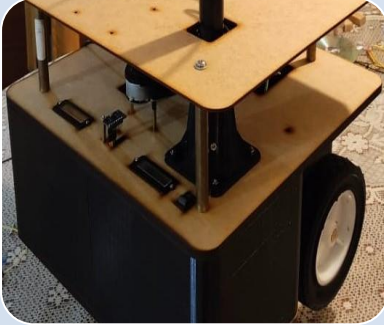

Plataforma
diferencial.

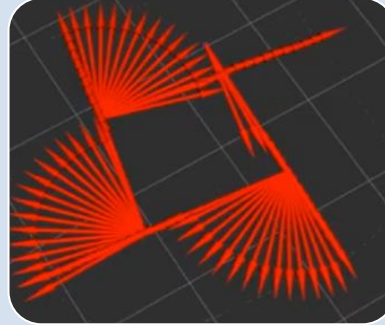

Velocidad de
desplazamiento
máxima 0,25 m/s
y 3,7% error.

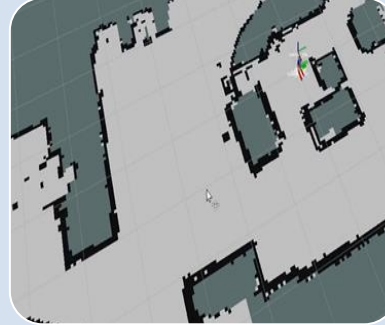

SLAM a
0,25 m/s y
5,45% error.

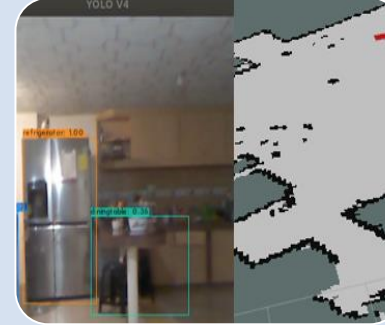

Ontologías
en
OWLready2

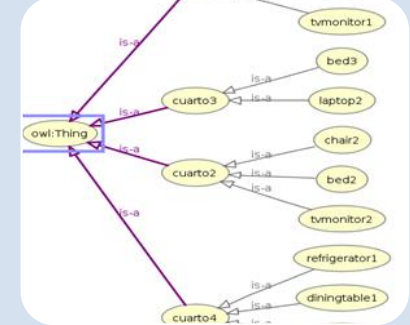

Mapa
semántico
en Protégé.



ESPE

UNIVERSIDAD DE LAS FUERZAS ARMADAS
INNOVACIÓN PARA LA EXCELENCIA



Recomendaciones

Segmentación Semántica

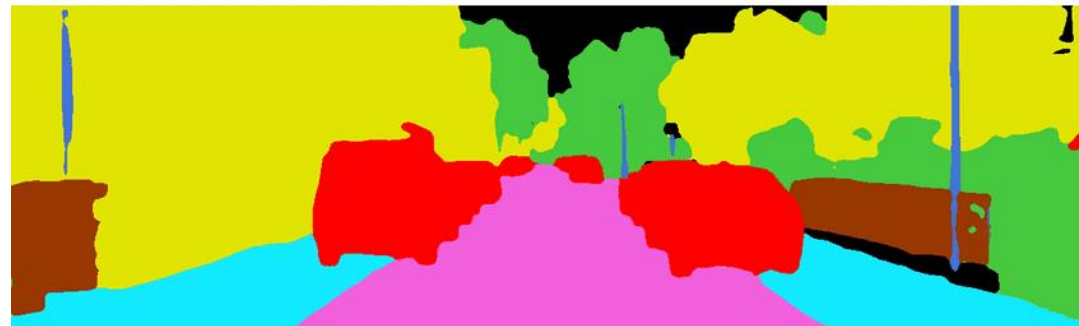

Trabajos Futuros

Razonamiento Ontológico

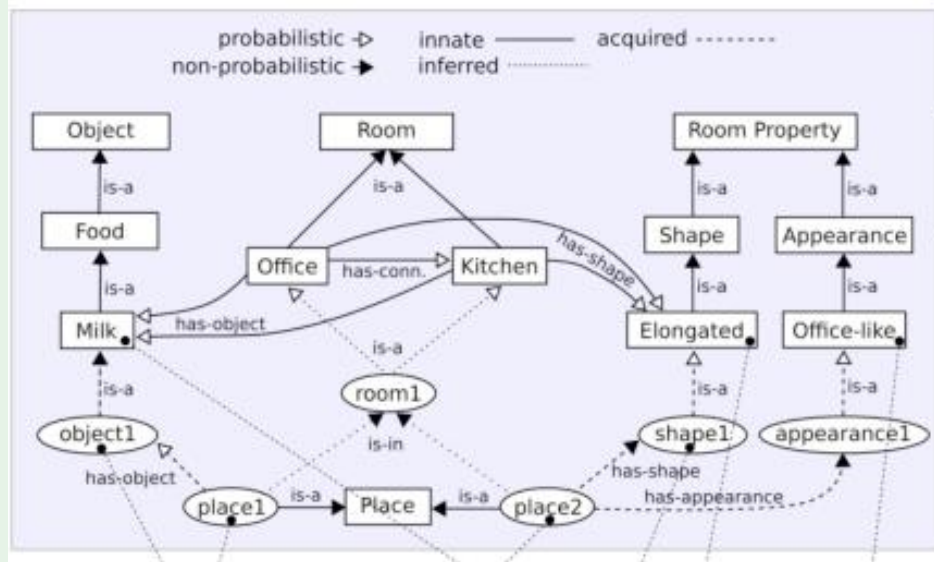

Fuente: (Pronobis 2011)

Representación Aumentada

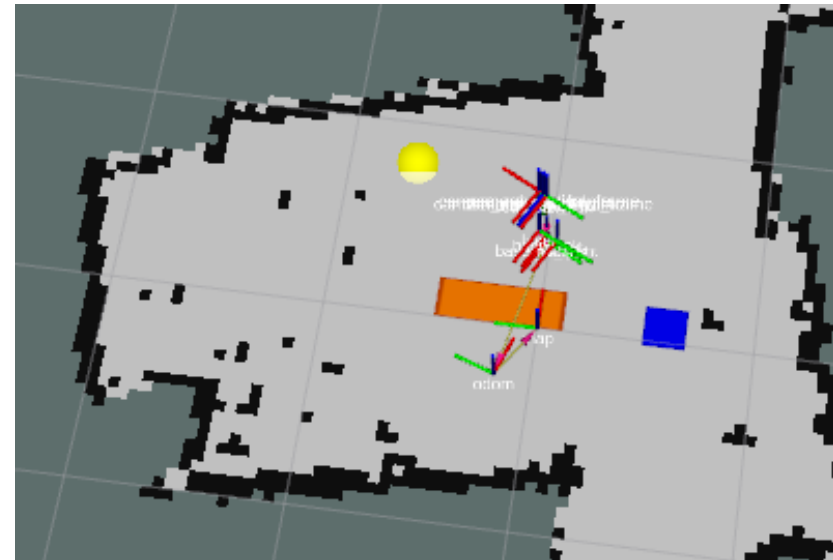



ESPE

UNIVERSIDAD DE LAS FUERZAS ARMADAS
INNOVACIÓN PARA LA EXCELENCIA



GRACIAS

efcanar@espe.edu.ec
+593995277836